

NOKIA

CONNECTING PEOPLE



**OWNER'S
MANUAL**

**NOKIA
5170**

Keys

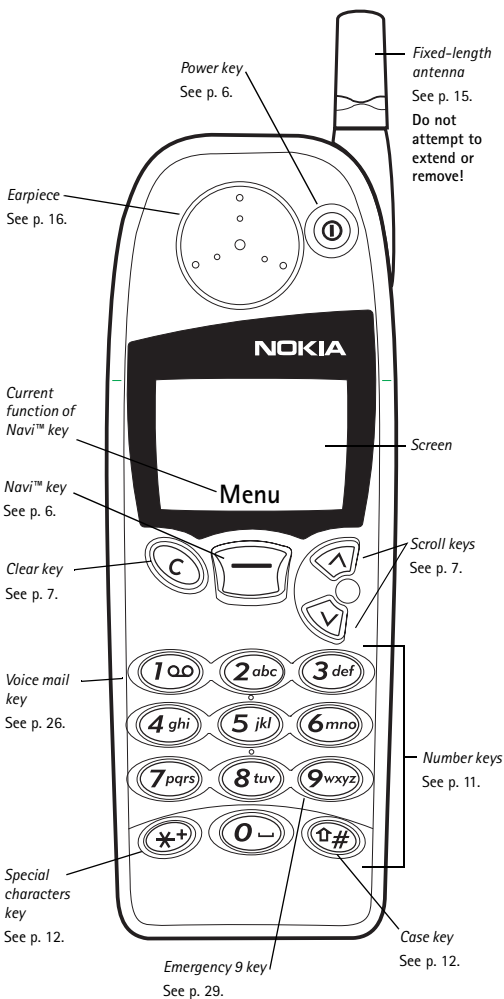

Indicators and icons



You are in an active call.



You have one or more new voice messages.



You have one or more new text messages.



Keyguard is on. Your phone will not accept any keypresses. To turn it off, press **Unlock**, then .



The alarm clock is set.



Tones are set to **Silent**. (Tones are turned off.)



Digital service is available.



Your phone is roaming outside its home system.



The phone is ready for you to enter a response.



Characters entered will be upper-case letters. Press the  key to switch letter case.



Characters entered will be lower-case letters. Press the  key to switch letter case.



Characters entered will be numbers. (When entering letters, switch to numbers by pressing and holding the  key.)

Contents

1.	For your safety	1
	FCC/Industry Canada Notice.....	2
	Using this Guide	2
2.	Battery installation & charging	3
	Attaching the battery	3
	Battery charging	3
	Removing the battery	4
	Important battery information.....	5
3.	About the phone, keys & menu	6
	Power key.....	6
	Nokia Navi™ key	6
	Ready screen	6
	Scroll keys	7
	Clear key.....	7
	Lights	7
	External antenna jack.....	8
	Menu	8
	Entering letters and numbers.....	11
	Special characters in names.....	12
	Special characters in phone numbers	12
	Keyguard (locking the keypad).....	13
4.	Basic functions	15
	Turning the phone on	15
	Turning the phone off.....	15
	About the antenna	15
	Checking signal strength	16
	Making a call	16
	Volume adjustment (earpiece)	16
	Muting the microphone	16
	Ending a call	17
	Last number redial.....	17
	Saving a name and number	17

	Finding a name and number	17
	Answering a call	17
	Silencing an incoming call	18
5.	Phone book	19
	Saving names and numbers	19
	Finding names and numbers	20
	Editing names and numbers	20
	Erasing names and numbers	21
	Finding your own number	21
	Scrolling view	21
	Checking available memory	21
6.	Settings	22
	Automatic redial	22
	Clock	22
	Language	23
	Lights	23
	Tones	23
	Quick alert settings	25
	Voice mailbox number	26
	Welcome note	27
7.	Emergency calls	28
	Emergency key 9	29
8.	Advanced functions	30
	Network feature setting	30
	Adding feature activation codes to the menu	30
	Adding feature cancellation codes to the menu	30
	In-call menu	31
	Making/receiving multiple calls	31
	Calling cards	33
	Call forwarding	34
	1-touch dialing	36
	Choosing your phone number (NAM selection)	37

Send own number	37
NAM update.	38
System selection	39
Automatic answer.	39
Touch tones	39
Restore factory settings	40
9. Call log	41
Missed calls	41
Received calls	42
Dialed calls.	42
Clearing call lists.	42
Call timers	42
10. Voice messages	44
Saving your voice mailbox number	44
Listening to new voice messages.	44
Calling your voice mailbox at any time.	45
11. Text messages	46
Reading messages	46
Storage of incoming messages.	47
12. Extra features	48
Alarm clock	48
Games.	49
13. Security features	51
Access codes overview	51
Lock code.	51
Security code.	51
Restricting calls.	51
Phone lock	55
14. Accessories	56
Nokia Xpress-on™ color covers	56
Batteries.	59
Chargers and other accessories	60

15. Reference information	64
Important safety information.....	64
Emergency calls.....	66
Radio frequency (RF) signals	67
Care and maintenance	68
16. Technical information	69
17. One-Year Limited Warranty	70
18. Index	74

1. For your safety



Read these simple guidelines before using your phone. Failure to comply with these guidelines may be dangerous or illegal.



Road Safety Comes First

Don't use a hand-held phone while driving; park the vehicle first.



Switch Off In Hospitals

Follow any regulations or rules. Switch phone off near medical equipment.



Switch Off On Aircraft

Wireless phones can cause interference. Using them on aircraft is illegal.



Switch Off When Refueling

Don't use phone at a refueling point. Don't use near fuel or chemicals.



Switch Off Near Blasting

Do not use the phone where blasting is in progress. Observe restrictions, and follow any regulations or rules.



Interference

All wireless phones may get interference which could affect performance.



Use Sensibly

Use only in the normal position (to ear). Don't touch the antenna unnecessarily.



Qualified Service

Only qualified service personnel must install or repair equipment.



Accessories and Batteries

Use only approved accessories and batteries. Do not connect incompatible products.

FCC/Industry Canada Notice

Your phone may cause TV or radio interference (for example, when using a telephone in close proximity to receiving equipment). The FCC or Industry Canada can require you to stop using your telephone if such interference cannot be eliminated. If you require assistance, contact your local service facility.

This device complies with part 15 of the FCC rules. Operation is subject to the condition that this device does not cause harmful interference.

Using this Guide

The wireless phone described in this guide is approved for use in CDMA 1900 networks.

Network services

A number of features included in this guide are called *network services*. They are special services provided by wireless service providers. Before you can take advantage of any of these network services, you must subscribe to the service(s) from your home service provider and obtain instructions for their use.

Updates

The latest version of this Owner's Manual may be found on Nokia's World Wide Web site at www.nokia.com.

2. Battery installation & charging

Before you can use your new phone, you need to attach and charge the battery.

Attaching the battery

To attach the battery, place it on the back of the phone as shown and slide it toward the top of the phone until it clicks into place.

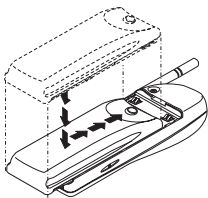

Battery charging

Your phone is powered by a rechargeable NiMH or Li-Ion battery. Note that a new NiMH battery's full performance is achieved only after two or three complete charge and discharge cycles (see 'Charging times' on page 59).

How to charge your battery

Connect the lead from the charger to the bottom of your phone or to a charging stand. Then plug the charger into a standard wall outlet.

When the battery is charging, the battery strength indicator on the right side of the screen scrolls upwards.

Note: When you charge the battery for the first time, the battery strength indicator will not scroll the entire time; this is normal.

Problems charging

If your phone displays **Not charging**, charging is suspended. Check that the battery is connected to an approved charging device. If the battery is very hot or cold, wait for a while; charging will automatically resume after the battery is restored to its normal operating state. If charging still fails, contact your dealer.

When is charging complete?

When the battery strength indicator stops scrolling, your phone is considered fully charged. However, a slight increase in charge may occur if you leave your phone connected to the charger.



Note: If you are using a lithium ion battery, continue to charge it for two hours after the indicator has stopped scrolling to retain "trickle charge".

When is a good time to charge?

You can charge anytime, but remember that when your phone displays **Battery low**, you only have a couple of minutes of talk time left.

Can I make calls while charging?

Yes, but your battery may not charge during a call. Charging should resume once you end the call.

Discharging NiMH batteries

For good operation times, discharge NiMH batteries from time to time by leaving your phone switched on until it turns itself off (or by using the battery discharge facility of any approved accessory available for your phone). Do not attempt to discharge the battery by any other means.

Removing the battery

Note: Switch off the phone before removing the battery!

- 1 Press and hold the button at the top of the battery.
- 2 Slide the battery toward the bottom of the phone.
- 3 Lift the battery off the phone.

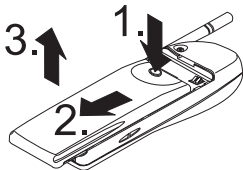

Important battery information

- The battery can be charged and discharged hundreds of times but it will eventually wear out. When the operating time (talk time and standby time) is noticeably shorter than normal, it is time to buy a new battery.
- Use only batteries approved by the phone manufacturer and recharge your battery only with the chargers approved by the manufacturer. When a charger is not in use, disconnect it from the power source. Do not leave the battery connected to a charger for longer than a week, since overcharging may shorten its life. If left unused a fully charged battery will discharge itself over time.
- Temperature extremes will affect the ability of your battery to charge: allow it to cool down or warm up first.
- Use the battery only for its intended purpose.
- Never use any charger or battery which is damaged or worn out.
- Do not short circuit the battery. Accidental short circuiting can occur when a metallic object (coin, clip, or pen) causes direct connection of the + and - terminals of the battery (metal strips on the back of the battery), for example when you carry a spare battery in your pocket or purse. Short circuiting the terminals may damage the battery or the connecting object.
- Leaving the battery in hot or cold places, such as in a closed car in summer or winter conditions, will reduce the capacity and lifetime of the battery. Always try to keep the battery between 59° F and 77° F (15° C and 25° C). A phone with a hot or cold battery may temporarily not work, even when the battery is fully charged. NiMH batteries' performance is particularly limited in temperatures below 14° F (-10° C). Li-Ion batteries' performance is particularly limited in temperatures below 32° F (0° C).
- Do not dispose of batteries in a fire!
- Dispose of used batteries in accordance with any local regulations.

3. About the phone, keys & menu

Power key

You can use the power key  to:

- turn the phone on or off (press *and hold*)
- turn the phone's lights on for 15 seconds
- select a quick alert setting (see page 25) (if Keyguard is off and the phone is not connected to a headset or handsfree car kit.)

For more information on Keyguard, see 'Keyguard (locking the keypad)' on page 13.

Nokia Navi™ key

Your phone's *Navi™* key  appears below the screen. Its current function is indicated by the word that appears above it (for example, **Menu**). Simply press the *Navi™* key to perform the function.

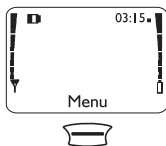



Throughout this guide, when you see "press **Menu**," "press **Listen**," etc., press the *Navi™* key when that word appears above it.

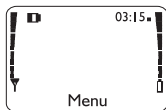

Ready screen



The *Ready screen* appears when you first turn on your phone. **Menu** appears above the *Navi™* key so you can access your phone's menu. Several features can be used only when the phone is at the Ready screen.



To get to the Ready screen, press and hold  for a second. (If there are characters on the screen this clears the characters, then you must press and hold  again.)

Scroll keys

The scroll keys   are located to the right of the Navi™ key. Use the scroll keys to:

- browse menus
- move the cursor (see page 11) to the right or the left
- adjust the earpiece volume while in a call
- access your phone book (press  from the Ready screen)
- access the dialed calls list (press  from the Ready screen)

For more information on the Ready screen, see 'Menu' on page 8.

Clear key

Use the clear key  to:

- delete a character to the left of the cursor
- clear all characters from the screen (press and hold)
- return to the previous menu level
- return from the menu to the Ready screen (press and hold)
- access the in-call menu while in a call (see 'In-call menu' on page 31)

Lights

To turn your phone's lights on for 15 seconds:

- if Keyguard is off, press any key
- if Keyguard is on, press the  key briefly

For information about controlling your phone's lights when the phone is in a car kit, see page 23.

External antenna jack

At the back of the phone, below the antenna, there is a connector for an external antenna. The connector may be protected by a rubber cap. Remove the cap before connecting an external antenna. After removing the antenna, replace the cap.

Note: Keep the cap out of the reach of small children.



Menu

Using your phone's menu you can easily access the many powerful features in your phone.



Scroll bar

When you use your phone's menu, a *scroll bar* appears at the far right of the screen. This bar indicates where you are in the menu; each tab location on the bar represents a different menu item.



For example, press **Menu** once. The scroll bar appears with the first (top) tab displayed. A different tab appears each time you press  or .

Help text

Many menu items have brief help text. To view the help text, scroll to the menu item and wait for approximately 10 seconds for the text to appear. Press **More** or  to see the next page of text,  to see the previous page, or  to return to the menu.

Menu shortcuts

When you select a menu item, numbers appear on the screen above the scroll bar. If you become familiar with these numbers, you can use them as shortcuts for accessing different menu items. For example, to access the **Phone settings** menu, you can simply press **Menu 4 2**. The phone displays the first item in that menu, **Touch tones**.



Note: (1) Menu items in your phone vary depending on the network and accessories used. (2) This is not a complete list; see entries about individual features for more information.

1 Phone book

- 11 Search
- 12 Add new
- 13 Edit
- 14 Options
 - 141 Scrolling view
 - 142 Memory status
- 15 1-touch dialing
- 16 Erase
 - 161 One by one
 - 162 Erase all
- 17 Own number

2 Messages

- 21 Text messages
 - 211 Inbox
 - 212 Saved
 - 213 Erase all
- 22 Voice messages
 - 221 Listen to voice messages
 - 222 Voice mailbox number
- 23 Welcome note

3 Call log

- 31 Missed calls
- 32 Received calls
- 33 Dialed calls
- 34 Clear call lists
 - 341 All
 - 342 Missed
 - 343 Received
 - 344 Dialed
- 35 Call timers
 - 351 Last call
 - 352 All calls
 - 353 Life timer
 - 354 Clear timers

4 Settings

- 41 Call settings
 - 411 Emergency key 9
 - 412 Automatic redial
 - 413 Calling card
 - 414 Automatic answer^A
- 42 Phone settings
 - 421 Touch tones
 - 422 Restore factory settings
 - 423 Language
 - 424 Lights^A
- 43 Security settings
 - 431 Restrict calls
 - 432 Access codes
- 44 Network services
 - 441 Call forwarding^M
 - 442 Call waiting^M
 - 443 Send own number^M
 - 444 Network feature setting
 - 445 NAM selection
 - 446 NAM update^O

5 System

- 51 Automatic
- 52 Home area^O

6 Games

- 61 Memory
- 62 Snake
- 63 Logic

7 Clock

- 71 Alarm clock
- 72 Clock settings
 - 721 Display/Hide clock
 - 722 Time settings
 - 723 Time format

8 Tones

- 81 Ringing options
 - 811 Ring
 - 812 Ascending
 - 813 Ring once
 - 814 Beep once
 - 815 Silent
- 82 Ringing tone
 - 32 tones
- 83 Ringing volume
 - 831 Level 1
 - 832 Level 2
 - 833 Level 3
 - 834 Level 4
 - 835 Level 5
- 84 Message alert tone
 - 841 No tone
 - 842 Standard
 - 843 Special
 - 844 Beep once
 - 845 Long & loud
- 85 Keypad tones
 - 851 Off
 - 852 Level 1
 - 853 Level 2
 - 854 Level 3
- 86 Warning and game tones
 - 861 On
 - 862 Off
- 87 Vibrating alert^A
 - 871 On
 - 872 Off

9 Keyguard



^A Depends on accessory; see entry for this feature

^M Must be added to the menu manually; see 'Network feature setting' on page 30

^O Depends on network or operator

Entering letters and numbers



Cursor

The *cursor* is a blinking vertical line that appears on the screen when you are entering text or numbers. Characters you enter appear to the right of the cursor. Press  to delete the character to the left of the cursor. Use  and  to move the cursor to the right or left.

ABC mode

When your phone is ready for you to enter text, such as a name or message, it switches to ABC mode. The **ABC** icon shows that it is in ABC mode.

When **ABC** is displayed, you can enter these characters by pressing the indicated key repeatedly:

Key	Characters	Key	Characters
1	., ' ? ! - 1	7	PQRS7
2	ABC2	8	TUV8
3	DEF3	9	WXYZ9
4	GHI4	0	space, 0
5	JKL5		See 'Special characters in names' on page 12.
6	MNO6		Changes letter case, switches between letters and numbers

Note: After you enter a character, press down on the scroll key to move the cursor over quickly.

Changing letter case



Press the  key (the Case key, shown on the phone diagram on this guide's inside front cover) to switch between upper- and lower-case letters. The **ABC** icon switches to **abc** to indicate that you are using lower case.

Entering numbers

To enter numbers while in ABC mode, you can:

- press and hold the corresponding key until the number appears, or
- switch between ABC mode and number mode by pressing and holding .

Special characters in names

In ABC mode you can press  (the Special characters key, shown on the phone diagram on this guide's inside front cover) to view the special characters below. You can use these characters when saving names in your phone book. Simply press  or  to highlight the one you want, then press **Use**.

. , ? ! : ; - + # * () ' " _ @ &t \$ £ % / < > ¿ ¡ § = [] ¥



Tip: To choose a character that appears near the end of the list, immediately press  to go to the end of the list.

Special characters in phone numbers

You can use special characters to dial or save phone numbers of automated services such as bank account information. When entering numbers, press  repeatedly until you see the character you want.

Character	Use
*	This character is used to request services from the network. Contact your service provider for details.

Character	Use
+	This character is not currently used.
p	This character creates a pause . Digits to the right of the p are sent as touch tones after a 2.5-second pause. Use this character to save phone numbers of automated services that require you to enter a password or other information after the call is answered. For example, if your voice mail number at work is 555-1212 and you need to enter your extension (1234) and then a password (5678) in order to listen to your messages, you could save this phone number as 5551212p1234p5678
w	This character creates a wait . It works similarly to the pause character except that digits to the right of the w are not sent until you press Send .

Keyguard (locking the keypad)

Using the Keyguard feature you can “lock” your phone’s keypad so that accidental keypresses have no effect. This is handy when your phone is in a pocket or purse.

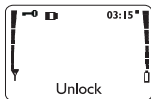

Note: Keyguard is not a security feature and will not prevent unauthorized use of your phone.

To lock the keys

Press **Menu 9** or **Menu** *****⁠**+**.

To unlock the keys

Press **Unlock** *****⁠**+**.

Notes about Keyguard

- When Keyguard is on, the only way to answer a call is to press **Answer**. Once the call is terminated, keyguard is reactivated.
- When Keyguard is on, press the power key briefly to turn your phone's lights on for fifteen seconds.
- When Keyguard is on, calls may be possible to the emergency number programmed into your phone (e.g. 911 or other official emergency number). However, one-key emergency dialing ('the 9 key') does not operate.

*Note: When Keyguard is active, the only way to make an emergency call is to dial the emergency number, then press **Call**.*

- Keyguard is automatically turned off when the phone is connected to a car kit. Once the phone is disconnected from the car kit, keyguard is reactivated.

4. Basic functions

Turning the phone on

Press and hold  for one second.

Note: Pressing  briefly turns your phone's lights on for fifteen seconds.

If the phone asks for a lock code, see 'Lock code' on page 51.
If the phone asks for a security code, see 'Security code' on page 51.

WARNING! Do not switch on the phone when wireless phone use is prohibited or when it may cause interference or danger.

Turning the phone off

If Keyguard is off, press and hold  for one second.

To deactivate Keyguard, press **Unlock** .

About the antenna

Your Nokia phone has a fixed-length antenna. Do not attempt to extend or remove it.

Normal position

Hold the phone as you would any other telephone, with the antenna pointed up and over your shoulder.

Tips on efficient operation

As with any other radio transmitting device, do not touch the antenna unnecessarily when the phone is switched on. Contact with the antenna affects call quality and may cause the phone to operate at a higher power level than otherwise needed.

Checking signal strength

Your phone operates on radio waves. Radio signal coverage is maintained by a wireless network, and the quality of calls on your phone depends on the strength of the wireless radio signal.

Get a strong signal

When you are at the Ready screen or in a call, the strength of the radio signal is indicated by the *signal strength indicator* on the left side of your phone's screen. This indicator scrolls up and down as the signal strength increases and decreases.





To improve your phone's reception, try moving your phone slightly. If you're inside a building, move toward a window.

Making a call

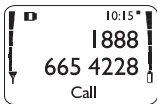

- 1 Enter the area code and phone number. (**Menu** changes to **Call**.)
- 2 Press **Call** and wait for the other party to answer.



Volume adjustment (earpiece)

To adjust the earpiece volume, press  or  during a call. If an accessory with its own loudspeaker is connected to your phone, the scroll keys adjust the volume for that accessory.

Muting the microphone

When you are in a call, you can mute the phone's microphone by pressing , pressing **Options**, and selecting **Mute**. To unmute the microphone, press , press **Options**, and select **Unmute**.

For more information, see 'In-call menu' on page 31.

Ending a call

Press **End**.

Last number redial

The last 10 numbers you dialed are stored in the dialed calls list. Use this list to redial a number you have called recently.

- 1 From the Ready screen, press  to access the dialed calls list.
- 2 Scroll to the desired number.
- 3 Press **Call**.

Saving a name and number

See 'Saving names and numbers' on page 19.

Finding a name and number

- 1 Press  to access your phone book.
- 2 Scroll to the number you want. (To skip ahead quickly in the list, press the number key that corresponds to the first letter of the name. For example, if you want to call your friend Katy, press the 5 key twice, quickly; once for the letter j, and once for the letter k.)
- 3 Press **Call**.

For other ways to find names and numbers, see 'Finding names and numbers' on page 20.

Answering a call

When someone calls, the phone alerts you (see 'Tones' on page 23) and **Call** flashes on the screen. To answer the call, press any key except .

Silencing an incoming call

To silence the ringing of the incoming call, press  briefly. You can still answer the call if **Call** or the name of the person is still flashing on your screen.

Note: To prevent accidental answering when the phone is in a pocket or purse, the phone will not answer the call if you press the key for longer than one second.

For information on setting your phone to answer incoming calls automatically, see 'Automatic answer' on page 39.

Caller ID

Caller ID is a network service that displays the phone number of the person calling you, if it is available. Check with your service provider for details.

If the caller can be identified, the phone displays the caller's phone number and **calling**. If the number matches a name saved in your phone book, the name is displayed instead.

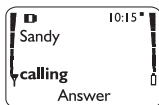



However, if the last seven digits of the phone number match more than one name in the phone book, only the phone number is displayed.

5. Phone book

For convenient and easy dialing, you can save 100 phone numbers and associated names in your phone.

Saving names and numbers



Saving a name and number is easy!

Just enter the phone number, press  or , then press **Save**.

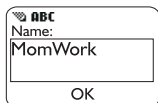
Enter a name if you wish, then press **OK**.



Saving a number quickly

To save a number quickly, enter the phone number, press  or , then press *and hold* **Save**. The number is saved to your phone book and you can add a name to it later (see 'Editing names and numbers' on page 20).

Saving a name and number while in a call

To save a name and number while in a call, enter the number, press **Options**, scroll to **Phone book**, scroll to **Add new**, enter a name if you like, and press **OK**. The phone displays the phone number you entered; edit it if necessary, then press **OK**.

Notes about saving names

- A name may appear only once in memory. If you try to save a name that already exists in memory, the phone asks if you want to replace the existing name.
- If you try to save a phone number and your phone book is full, you are given the option to replace an existing entry. Scroll to the entry you want to replace and press **OK**, or press  to cancel.

Finding names and numbers

There are several ways to find names and numbers in your phone book.

From the Ready screen

Press  to access your phone book, then scroll to the desired name/number.



Tip: You can also press the number key that corresponds to the first letter of the name. (To skip ahead quickly in the list, press the number key that corresponds to the first letter of the name. For example, if you want to call your friend Katy, press the 5 key twice, quickly; once for the letter j, and once for the letter k.) The first matching entry is displayed at the top of the screen.

Using the Phone book menu

Press **Menu** 1 1, enter the first few letters of the name, then press **OK**. Your phone displays the first matching entry at the top of the screen.

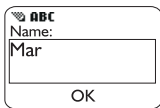

While performing other functions

Say you want to forward your phone calls to a number that is saved in your phone book. When you are prompted to enter the phone number, you can find it instead—simply press **Search** to access your phone book.

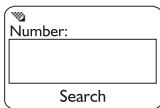

Editing names and numbers

To edit phone book entries, press **Menu** 1 3, scroll to the entry you want to edit, then press **Edit**. Edit the name and number as needed.

Erasing names and numbers

Use **Menu 1 6** to erase entries from your phone book. **One by one** lets you select one entry at a time to be erased. **Erase all** erases your entire phone book (you are required to enter your security code first).

Finding your own number

Use **Menu 1 7** to view your phone's number.

Scrolling view

Use **Menu 1 4 1** to choose a scrolling view for your phone book (**Name list**, **Name+number**, or **Name only**).



Tip: If you're viewing your phone book and scrolling view is set to **Name list** or **Name only**, you can view the phone number associated with a name by pressing and holding .

Checking available memory

Use **Menu 1 4 2** to see how many memory locations are free and how many are being used. (Each memory location holds one phone number and associated name.)

6. Settings

This section describes some phone settings that allow you to customize your phone to suit your preferences and that you probably won't change very often.

Automatic redial

Use **Menu 4 1 2** to turn this feature on or off. When this feature is on and the wireless network is busy, your phone redials a number up to three times. This feature does not redial to a busy phone number.

To stop the call attempts, press **Quit** or .

Clock

Your phone has an internal clock that can be displayed on the Ready screen.

If you remove the battery for longer than a couple of seconds, the time is lost. The next time you turn on the phone, you will be asked to enter the time.

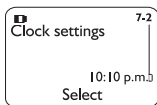

Setting the time using the network

To set the time on your phone using the network (the default setting), use **Menu 7 2 2 1**. If your phone is unable to get the time from the network, you are prompted to enter the time manually. (For example, your phone may not be able to get the time from the network if you don't have digital coverage.)

Setting the time manually

Use **Menu 7 2 2 2** to enter the current time. Use two digits for both hours and minutes (for example, enter 1:30 as **0130**). If the clock's time format is set to **am/pm**, you are asked to choose **am** or **pm**.

Note: Pressing  does not work on this screen. If you make a mistake, re-enter all four digits.

Selecting time format

Use **Menu 7 2 3** to set the clock's format to **am/pm** or **24-hour**.

Displaying or hiding the clock

Press **Menu 7 2 1** to display the clock on the phone's screen if it is currently hidden, or vice versa.

When the clock is displayed and the time format is set to **am/pm**, a black square appears next to the time indicating a.m. or p.m.

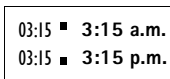

Language

Use **Menu 4 2 3** to set the language of your phone's screen. You can choose from English, French, Spanish, Portuguese, and Hebrew.

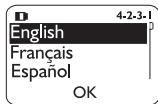

The shortcut for choosing English is to press **Menu 4 2 3 1**.

Lights

If you're using your phone with a car kit, your phone's lights turn on and remain on automatically. Use **Menu 4 2 4** to set your phone's lights to **Automatic** (after 15 seconds, the lights turn off until the next key is pressed, phone rings, etc.).

For information about turning your phone's lights on at any time, see page 7.

Tones

Use **Menu 8, Tones**, to change the six sound settings in your phone: ringing option, ringing tone, ringing volume, message alert tone, keypad tones, and warning and game tones.

Using the quick alert settings feature (see page 25) you can select a fixed combination of these settings to suit your current environment.

Ringling option

Use **Menu 8 1** to tell your phone how to notify you that you have a call.

Note: If you choose **Beep once** or **Silent**, the alarm clock only sounds a quiet beep.

Ring The phone rings normally using the currently selected ringing tone.

Ascending The phone rings using the currently selected ringing tone. The ringing volume starts low and increases to selected volume with successive rings.

Ring once The phone rings once using the currently selected ringing tone.

Beep once The phone beeps once.

Silent The phone makes no sound when you receive a call. The  icon appears on the Ready screen.

Ringling tone

If your ringing option is set to **Ring once**, your phone plays a ringing tone when someone calls you. Use **Menu 8 2** to choose one of 32 ringing tones. Scroll to a tone to hear how it sounds.

Note: If the ringing option is set to **Silent** or **Beep once**, the phone won't play sample tones.

Ringling volume

Use **Menu 8 3** to control the volume of your phone's ringing and of message alert tones.

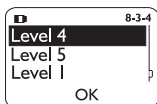

Message alert tone

Use **Menu 8 4** to choose the tone played when you receive a text message. Scroll to a tone to hear how it sounds.

Keypad tones

Use **Menu 8 5** to adjust the volume of the tones your phone makes when you press its keys.

Warning and game tones

Use **Menu 8 6** to turn your phone's warning and game tones on or off. Warning tones are created by events such as confirmations, errors, power on, battery low, and recharge battery.

Vibrating alert

If your phone has a vibrating battery attached, use **Menu 8 7** to set your phone to vibrate when you receive a voice call. If you turn vibrating alert on, your phone vibrates even if its ringing option is set to **Silent**.

Note: The vibrating battery does not vibrate when your phone is connected to or placed in any charging device, or if it's connected to a car kit.

Quick alert settings

You can quickly adjust your phone's sound settings when you go into a meeting, go outdoors, etc. To choose a quick alert setting, briefly press **ⓘ**, scroll to the setting you want, then press **OK**.

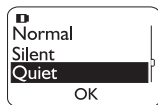

Note: You can only access your phone's quick alert settings from the Ready screen.



Tip: Instead of using the scroll keys, you can press **ⓘ** repeatedly to scroll through this menu. After you reach the setting you want, press *and hold* **ⓘ**.

Note: If you choose **Silent** or **Quiet**, the alarm clock only sounds a quiet beep.

Normal Your phone uses the settings you made in **Menu 8, Tones**.

Silent All sound is turned off in your phone. The  icon appears on the Ready screen.

Quiet Your phone beeps once when you receive a call or text message. Other tones are turned off.

Loud Your phone rings loudly. Keypad tones, message alert tone, and warning tones are also loud.



Headset Your phone automatically selects this when it is connected to a headset. Your phone remembers any changes you make to settings in **Menu 8, Tones**, and uses them the next time you connect the phone to a headset.

Car Your phone automatically selects this when it is connected to a car kit. Your phone remembers any changes you make to settings in **Menu 8, Tones**, and uses them the next time you connect the phone to a car kit.

Note: If the **Silent**, **Quiet**, or **Loud** quick alert setting is chosen and you change a setting in **Menu 8, Tones**, your phone switches the current quick alert setting to **Normal**.

To return to the Ready screen, press .

Voice mailbox number

If you have a voice mail subscription, use **Menu 2 2 2** to save the voice mailbox number given to you by your service provider. This number may be up to 32 digits long. Once you save your voice mailbox number, you can press and hold  to dial your voice mailbox. (You can also press  briefly and then press **Call**.)

For more information, see 'Voice messages' on page 44.

For any questions about your voice mail, contact your service provider.

Welcome note

Use **Menu 2 3** to create or change the welcome note for your phone. This note is displayed briefly each time you turn on your phone. It can be your name, a reminder, etc. To save the note, press **Options**, then **Save**. To erase the note, press **Options**, then **Erase**.



7. Emergency calls

- 1 If the phone is not on, switch it on.
- 2 Press and hold  for several seconds to ready the phone for calls.
- 3 Key in the emergency number for your present location (e.g. 911 or other official emergency number). Emergency numbers vary by location.
- 4 Press **Call**.

IMPORTANT!

This phone, like any wireless phone, operates using radio signals, wireless and landline networks as well as user-programmed functions which cannot guarantee connection in all conditions. Therefore you should never rely solely upon any wireless phone for essential communications (e.g. medical emergencies).

Remember, to make or receive any calls the phone must be switched on and in a service area with adequate signal strength. Emergency calls may not be possible on all wireless phone networks or when certain network services and/or phone features are in use. Check with local service providers.

If certain features are in use (Keyguard, call restrictions, etc.), you may first need to turn those features off before you can make an emergency call. Consult this document and your local cellular service provider.

When making an emergency call, remember to give all the necessary information as accurately as possible. Remember that your wireless phone may be the only means of communication at the scene of an accident - do not cut off the call until given permission to do so.

Emergency key 9

Use **Menu 4 1 1** to turn on this feature. When this feature is on, the phone attempts to make an emergency call when you:

- press and hold the 9 key, or
- press 9, then press **Call**.

*Note: When Keyguard is active, the only way to make an emergency call is to dial the emergency number, then press **Call**.*

IMPORTANT!

Official emergency numbers (for example, 911) vary by location. Only one number is dialed automatically by Emergency Key 9, and it might not be the proper number in all circumstances.

8. Advanced functions

Network feature setting

Call forwarding, call waiting, and send own number are network services available through your service provider. These features do not appear in your phone's **Network services** menu until you save the related feature code(s) given to you by your service provider. After you save the feature activation or cancellation code, the feature appears in the phone's menu and you can use the menu to turn the feature on or off.

Note: Feature codes can be saved only when your primary phone number (NAM 1) is selected. See page 37.

Adding feature activation codes to the menu

To save a feature activation code, press **Menu 4 4 4**. At the **Feature code:** prompt, enter the feature activation code, then press **OK**. Scroll to the feature that the code applies to, then press **Select**. (If the feature is call forwarding, choose one of the four types of call forwarding.) Finally, scroll to **Activate**, then press **OK**.

Activate now appears in the menu for that feature.

Adding feature cancellation codes to the menu

To save a feature cancellation code, press **Menu 4 4 4**. At the **Feature code:** prompt, enter the feature cancellation code, then press **OK**. Scroll to the feature that the code applies to, then press **Select**. (If the feature is call forwarding, choose one of the four types of call forwarding.) Finally, scroll to **Cancel**, then press **OK**.

Cancel now appears in the menu for that feature.

In-call menu

When you are in a single call, the Navi™ key function is **End**. However, you can use your phone's in-call menu to perform several functions while in a call. To access the in-call menu, press  to change the Navi™ key function to **Options**, then press **Options**.

*Note: If you have an active call and an incoming or held call, pressing  isn't necessary; **Options** appears automatically.*

If you receive a call while in a call, the Navi™ key function changes to **Answer**.

Depending on the number of active calls and whether you are using digital or analog mode, the following in-call options may be available:

Mute/End mute	mute/unmute the phone's microphone
Flash	switch between calls/answer waiting call/ make new call
End	end all calls
Touch tones	send touch tones
Menu	access your phone's menu
Phone book	access the phone book

Making/receiving multiple calls

Note: The following two features might not be supported in your network. Contact your service provider for details.

Making a new outgoing call

Type in the phone number you wish to call and press **Options** to access the in-call menu. Then, press **Flash**. The first call is automatically put on hold. To join the calls, press **Flash** again.

Receiving a new call

If you are in a call and you receive a call, press **Answer**. The first call is automatically put on hold. To swap between the calls, press **Flash**.

Ending all calls

Select **End** from the in-call menu.

Call waiting

Call waiting is a network service that allows you to receive an incoming call when you're already in a call. Contact your service provider for details.

Answering a waiting call

When you receive a call while already in a call, the Navi™ key function changes from **End** to **Answer**. Press **Answer** to answer the waiting call. The call you were in is put on hold, and the Navi™ key function changes to **Options**. To switch between calls, or to end all calls, press **Options** to access your phone's in-call menu.

For complete information on your phone's in-call menu, see 'In-call menu' on page 31.

Cancelling call waiting: normal method

To cancel call waiting before making a call, you must get the call waiting cancellation code from your service provider.

- 1 Dial the code for cancelling call waiting (for example, *810).
- 2 Press **Call**.

Cancelling call waiting: menu method

You can save the code for cancelling call waiting given by your service provider and then use **Menu 4 4 2 2** to cancel call waiting. See 'Adding feature cancellation codes to the menu' on page 30.

Calling cards

If you wish to use a calling card for long distance calls, you must first save your calling card information into your phone. Your phone can save information about four calling cards.

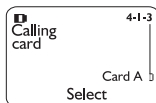

Saving calling card information

- 1 Press **Menu** 4 1 3.
- 2 Scroll to the desired calling card, then press **Options**.
- 3 Scroll to **Edit**, then press **OK**.
- 4 Enter your security code (see page 51), then press **OK**.
- 5 At **Dialing sequence**, press **Select**. Press  to choose the dialing sequence your card uses, then press **Select**.

Dialing sequence	Use for cards that require you to:	Cards using this sequence
Access no. + phone no. + card no.	Dial 1-800 access number, then phone number, then card number (+ PIN if required)	MCI, AT&T True Choice, Sprint Canada, Unitel
Access no. + card no. + phone no.	Dial 1-800 access number, then card number (+ PIN if required), then phone number	networkMCI, WorldPhone MCI
Prefix + phone no. + card no.	Dial the prefix (any numbers that must precede the phone number) and phone number you want to dial, then card number (+ PIN if required)	GTE, PacBell, AT&T, Stentor

Note: The order of the following steps may vary, depending on which dialing sequence your card uses.

- 6 Enter the access number (usually the 1-800 number listed on the back of the calling card), then press **OK**.
- 7 Enter your card number and/or PIN, then press **OK**. Your phone will display **Save changes?** Press **OK**.
- 8 Press  to reach **Card name**, then press **Select**. Enter the card name using your phone's keypad, then press **OK**.

Note: This procedure might not work with all calling cards. Please look at the back of your calling card or contact your long distance company for more information.

Choosing a calling card to use

Use **Menu 4 1 3** to select a calling card to use. You are required to enter your security code.

Calling card calls

To make a call using a calling card:

- 1 Enter the phone number, including any prefix (such as 0 or 1) that your calling card may require when you make a calling card call (see your calling card for instructions).
- 2 Press and hold **Call** for a few seconds until your phone displays **Card call**.
- 3 Your phone displays **Wait for tone, then press OK**. Wait for the tone, then press **OK**.

Your phone displays **Wait for tone, press OK again**. Wait for the tone again, then press **OK**.

Call forwarding

Call forwarding is a network service that lets you forward your incoming calls to another phone number. Check with your service provider for details and feature codes.

Activating call forwarding

Standard method

To activate call forwarding, you must get the call forwarding activation code from your service provider.

- 1 Dial the code for activating call forwarding followed by the phone number to which you want to forward your calls.
- 2 Press **Call**.

Example: If the call forwarding activation code is *71 and the number you want to forward calls to is (214) 555-1234, dial ***712145551234**, then press **Call**.

Menu method

You can save the code for activating call forwarding and then use the menu to activate call forwarding (see 'Adding feature activation codes to the menu' on page 30).

Cancelling call forwarding

Standard method

To cancel call forwarding, you must get the call forwarding cancellation code from your service provider.

- 1 Dial the code for cancelling call forwarding (for example, *710).
- 2 Press **Call**.

Menu method

You can save the code for cancelling call forwarding and then use the menu to cancel call forwarding (see 'Adding feature cancellation codes to the menu' on page 30).



1-touch dialing

1-touch dialing lets you make phone calls quickly and easily with the touch of a button. Once you have assigned a phone number to a number key (2 through 8), you can press and hold that key to dial the number. (You can also press and hold the number key and then press **Call**.)

Note: Keys 1 and 9 are used exclusively for dialing your voice mailbox and for attempting emergency calls, respectively (see 'Voice messages' on page 44 and 'Emergency calls' on page 28).

Assigning numbers to keys

Before you can assign a phone number to a key, the phone number must be saved in your phone book (see page 17). Then follow the steps below.

- 1 Press **Menu** 1 5.
- 2 Scroll to the desired key, then press **Assign**.
- 3 Press  or  to choose the name you want to assign to the selected key, then press **Select**.

If a key already has a number assigned to it, you can press **Options** and then view, change, or erase the number assignment.

Making calls using 1-touch dialing

Press and hold a number key (2 through 8) for a few seconds to call the number assigned to it. Your phone finds the phone number, displays it briefly, then dials it.

You can also enter the number of the 1-touch dialing key (for example, 2) and press **Call**.

Choosing your phone number (NAM selection)

Your service provider can set up your phone to have two phone numbers that are activated in different service areas—for example, one number for the Dallas area and one number for the Chicago area.

A number assignment module, or NAM, consists of a phone number and network information that the service provider programs into your phone. When you select a NAM, you're not only selecting a phone number, you're also selecting a home system in which you will not be charged roaming fees.

Use **Menu 4 4 5** to select a NAM.

Send own number

Send own number is a network service that lets you hide your phone number from a person you are calling who has Caller ID. (If for some reason your network prevents phone numbers from being displayed, you may be able to use this feature to **show** your number to the person you are calling.) Contact your service provider for feature codes for showing/hiding your phone number.

Standard method

- 1 Dial the feature code followed by the number you want to call.
- 2 Press **Call**.

Example: If the feature code to hide your number is *67 and the number you want to dial is (214) 555-1234, dial ***672145551234**, then press **Call**.

Menu method

You can save the feature code given to you by your service provider so that **Send own number** appears in your phone's menu, and then use **Menu 4 4 3** to use this feature (see 'Network feature setting' on page 30).

This feature must be activated before each call; you cannot permanently turn it on or off.

Yes displays your number to the person you are calling.

No prevents your number from being shown to the person you are calling.

NAM update

Note: This feature may not be available in all systems. Please contact your service provider for details about the availability of this feature.

With this feature you can activate or reactivate your phone without having to go to your service provider. Please refer to the Easy Activation card that was included in your sales package for more information on how to activate or reactivate your phone.

In some cases, when you try to connect to your service provider, the following message may appear on the screen:

'LOCK' prevents the service provider from changing your carrier lock code. 'UNLOCK' allows the provider to change the code and restrict others from activating your phone.

If this happens, select the appropriate selection for your phone. If you don't want your service provider to change your lock code, select **LOCK**. If you want to allow your service provider to change your code to prevent other service providers from activating your phone, press **UNLOCK**.

Press and hold  for several seconds to return to the Ready screen.

Note: Contact your service provider if you have any questions.

System selection

Using *system selection*, you can choose how your phone selects a network to use. This feature is **Menu 5** in your phone. The default is **Automatic**, which means your phone automatically searches for networks available to you and chooses the appropriate one.

If you choose **Home area**, your phone does not go into roam mode, and you will not be billed roaming charges.

Note: This text may not appear in some systems.

Automatic answer

This feature is available only when your phone is connected to a headset or to an approved handsfree car kit equipped with the ignition sense option, with the ignition on.

When automatic answer is turned on, your phone answers incoming voice calls after one ring. Use **Menu 4 1 4** to turn this feature on or off.

Touch tones

Your phone can generate various sounds, called *touch tones*, when the keys are pressed.

Touch tones can be used for many automated services such as checking voice mail, movie times, and airline arrival/ departure times.

Note: Sending confidential information over the air using touch tones is not recommended.

Setting manual touch tone length

Use **Menu 4 2 1 1** to set the length of touch tones created when you press a key:

Continuous sounds the tone for as long as you press and hold the key.

Fixed sets the tone length to one tenth of a second, regardless of how long you press and hold the key.

Off turns off touch tones. No tones are sent when you press the keys.

Setting automatic touch tone length

Use **Menu 4 2 1 2** to set the length of touch tones sent automatically by the phone to **Short** (one tenth of a second) or **Long** (half a second).

Saving touch tone strings

Touch tone strings can be used for sending and receiving information with your phone. Save touch tone strings the same way you save phone numbers (see 'Saving names and numbers' on page 19).

For example, you can save your office voice mailbox number along with your password for easy access to your messages (see 'Special characters in phone numbers' on page 12).

Sending touch tone strings

- 1 During a call, press  to clear any numbers from the screen.
- 2 Press **Options**.
- 3 Scroll to **Touch tones**, then press **OK**.
- 4 Enter or find the touch tone string, then press **OK**.

Restore factory settings

You can use **Menu 4 2 2** to reset many of the settings in your phone to their factory defaults (as in a new phone). You are required to enter the security code.

Note: The phone book, language setting, call timers, security code, and lock code are not affected.

9. Call log

For your convenience, the *call log* (Menu 3) saves a list of phone numbers you have dialed, and can show you approximately how much time you have spent on the phone. If you subscribe to the caller ID network service, the call log also records the phone numbers of missed calls and received calls. Contact your service provider for details.

The Options key

When you access **Missed calls**, **Received calls**, or **Dialed calls** and press **Options**, a list of options appears on your phone's screen.

Call dials the number.

Call time shows the time of the call. (Your phone's clock must be set; see page 22.)

Use number shows you the number before you dial it.

Save lets you enter a name for the number, edit the number if needed, and save both to your phone book.

Erase erases the number from the call list.

View number displays the associated phone number if only the name is currently displayed.

Missed calls

If you subscribe to the caller ID network service, your phone automatically stores the last 10 numbers that have tried unsuccessfully to reach you (as long as the caller allowed his or her number to be shown to you).

When the screen says Missed calls

Press **List**. If you have missed more than one call, you can scroll through the list of numbers. To dial the displayed number, press **Options**, then choose **Call**.

Viewing the missed calls list at any time

Use **Menu 3 1** to view the missed calls list at any time. To dial a number, press **Options**, then choose **Call**.

Received calls

If you subscribe to the caller ID network service, your phone automatically stores the phone numbers of the 10 most recent calls you've answered. Use **Menu 3 2** to view the received calls list. To dial a number, press **Options**, then choose **Call**.

Dialed calls

Your phone automatically stores the last 10 numbers you've dialed. From the Ready screen, press  to access the dialed calls list. Scroll to the desired number, then press **Call**.

*Note: To perform any of the options listed on page 41, access the dialed calls list by pressing **Menu 3 3**.*

Clearing call lists

Use **Menu 3 4** to clear the missed, dialed, and/or received call lists.

Call timers

Use **Menu 3 5** to access this feature.

Call timers lets you see the amount of time you've spent in calls. Times are for the currently selected phone number; your phone has a separate timer for each phone number, or NAM (see page 37).

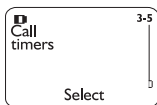

Note: The actual time invoiced for calls by your service provider may vary, depending upon network features, rounding-off for billing, and so forth.

Viewing call timers

Use **Menu 3 5** to view the various call timers.

Last call displays the duration of the last call, or current call if applicable.

All calls displays the duration of all calls since the timers were last reset.

Life timer displays the duration of all calls for the life of your phone and cannot be reset.

Setting timers back to 0

Use **Menu 3 5 4** to clear call timers. You are required to enter your security code.

Displaying the current call timer during calls



- 1 Press **Menu 3 5 1**.
- 2 Press **Details**.
- 3 Press **Select**.
- 4 Scroll to **On**, then press **OK**.

During a call, the amount of time spent in that call is displayed for ten seconds.

10. Voice messages

Voice mail is a network service that allows callers to record a message when you cannot be reached. You can then call your voice mailbox and retrieve your messages.

Saving your voice mailbox number

When you subscribe to voice mail, your service provider gives you a voice mailbox number. You should save this number so you can call your voice mailbox by pressing and holding , or by pressing  then **Call** (see 'Voice mailbox number' on page 26).

In addition to a voice mailbox number, your service provider may also give you a password, which you can save along with your voice mailbox number. This way, you can access your voice mailbox and then quickly send your password by pressing the Navi™ key rather than dialing your password separately.

If your service provider gives you a password and you want to save it with your voice mailbox number, refer to 'Special characters in phone numbers' on page 12.

Listening to new voice messages

When you receive a voice message, your phone may notify you by beeping, displaying the voice message indicator , and displaying **New voice message**. The phone may display the number of messages if there is more than one.

Note: The method of notification depends on your service provider.

When your phone notifies you that you have a new voice message, press **Listen**. Your phone dials your voice mailbox number, if you have saved it.

If you received a voice mailbox password, and if you saved it with your voice mailbox number, follow these steps:

- 1 When your phone notifies you that you have a new voice message, press **Listen**. Your phone dials your voice mailbox number, and your password displays.
- 2 When your phone notifies you that you're able to listen to your messages, press **Send**.

Note: The method of notification depends on your service provider. If you have any questions about voice messaging, contact your service provider.

Calling your voice mailbox at any time

Once you have saved your voice mailbox number, you can press and hold  to dial your voice mailbox.

11. Text messages

With the text message network service you can receive text messages from a variety of sources, such as another wireless phone or a Web site set up by your service provider.

Your phone can handle messages of up to about 250 characters, and has space to receive up to about 30 messages, depending on the length of each one.

Contact your service provider for more information about this network service.

Reading messages

When you receive a text message, the phone displays the  indicator, either **Message received** or **New emergency message** (if an emergency message has been received), and makes a sound (depending on the message alert tone; see 'Message alert tone' on page 25).

To read the message, press **Read**. This takes you to the Inbox, with the new message selected. Press **Read** again. If necessary, use the scroll keys to read the entire message.

After reaching the end of the message, use the scroll keys to view the sender's name or phone number, and the date and time the message was received.

Options when reading messages

Several options are available while you're reading a message. Just press **Options**, scroll to the one you want, then press **OK**.

Erase deletes the message. Press **OK** to confirm the deletion (or  to cancel).



Use number calls any phone number included in the message. If more than one number was included, a list of numbers is displayed. Choose one and press **Call**.

Save saves the message in the **Saved** folder.

When you've seen the last new message, the  indicator disappears.

About the Inbox

The Inbox holds text messages that have not been deleted or saved. Use **Menu 2 1 1** to access the Inbox at any time (you are required to enter your security code first).

You see a list of message headers. The  icon in front of the header indicates that a message has been read. The  icon indicates that a message has not been read. Scroll to the desired message, then press **Read**.

About the Saved folder

The *saved folder* holds up to 30 saved text messages and a total of 2000 characters. Use **Menu 2 1 2** to access the Saved folder and read saved messages (you are required to enter your security code first).

About the Erase all option

Erase all allows you to erase all text messages, or you can erase all messages in either the Inbox or the Saved folder. You are required to enter your security code before erasing all messages. Unread text messages are not erased.

Storage of incoming messages

When you have an incoming text message and your phone's memory is full, one or more low-priority messages are automatically deleted in order to receive the new text message. Messages are usually deleted from your Inbox, but an emergency message may cause messages to be deleted from the Saved folder. Unread text messages are not erased.

If the message memory is still full, your phone displays **No space: message waiting**. You can clear this notification by pressing **OK**. You should delete one or more old messages to make room for the new message. The network will re-send the message at a later time.

12. Extra features

Alarm clock

The alarm clock feature sounds an alert at a time you specify.

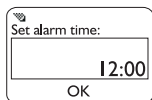

Setting the alarm clock

Use **Menu 7 1** to turn the alarm clock on or off.

Note that when you're entering the alarm time, use two digits for both hours and minutes (for example, enter 1:30 as **0130**).

*Note: Pressing **C** does not work on this screen. If you make a mistake, re-enter all four digits. Press up or down on the scroll keys to move the cursor. The number you press is entered to the right of the cursor.*

Alarm volume

The alarm volume is determined by the current ringing volume. However, if you have manually set the ringing option (see page 24) to **Silent** or **Beep once** or have selected the **Silent** or **Quiet** quick alert setting (see page 25), the phone only sounds a quiet beep.

When the alarm sounds

- To shut off the alarm, press any key except **Snooze**.
- If you press **Snooze**, the alarm sounds again in ten minutes. To turn off the alarm before then, press **Stop**.
- If you let the alarm sound for one minute without pressing a key, it stops for ten minutes, then starts again.

If you turn off the phone

If you turn off the phone and the alarm is set, the phone switches itself on at alarm time, then the alarm sounds.

- To shut off the alarm, press any key except **Snooze**. The phone displays **Keep the phone on?**. Press **Yes** to keep it on or  to switch it off.
- If you press **Snooze**, the phone turns itself off for ten minutes, then the alarm sounds again.



REMEMBER! Do not switch on the phone when wireless phone use is prohibited or when it may cause interference or danger.

Games

Use **Menu 6** to challenge yourself or a friend to the three fun games in your phone. To pause a game, press . To resume, choose **Continue**.

REMEMBER! Your phone must be switched on to use this function. Do not switch on the phone when wireless phone use is prohibited or when it may cause interference or danger.

Memory

Reveal pictures to find pairs in as few tries as possible. Move the cursor with the 2 (up), 4 (left), 6 (right), and 8 (down) keys. Press the 5 key to reveal pictures. Once found, pairs stay visible. Press  to jump to the right over revealed pictures or to move from the bottom right of the screen to the top left. Press  to jump to the left over revealed pictures or to move from the top left of the screen to the bottom right.

Snake

Feed the snake with as many goodies as possible and watch it grow. Use keys 2, 4, 6, and 8 to turn the snake toward food. The longer the snake's tail grows, the higher your score. If the snake hits its own tail or the surrounding wall, the game is over.

Logic

Find the secret combination of figures in a column. Possible figures are shown at the top of the screen. Press the 5 key repeatedly to select a figure and the 2, 4, and 8 keys to move the cursor. Once you think you have the right combination, press . The result appears as a set of marks above the column. A correct figure in the right place gets a full mark; a correct figure in the wrong place gets a half mark. The game ends when the correct figures are in the right place.



Tip: To copy a figure from the previous column, move the cursor over it using the 2, 4, or 8 key, then press the 5 key.

13. Security features

Access codes overview

Access codes consist of the lock code and security code. When you get your phone, you should change these codes from their defaults, write down the new codes, and keep them in a safe place away from the phone. Avoid using access codes that are similar to emergency numbers, such as 911, to prevent accidental dialing of the emergency number.

Lock code

Your phone's *lock code* is used to lock and unlock your phone. The default lock code is 1234. Use **Menu 4 3 2 3** to change the lock code.

When the phone requires the lock code, it displays **Enter lock code:**. Enter the code, then press **OK**.

If you enter a wrong lock code five times in succession, your phone prompts you for the security code.

Security code

The *security code* is required to restrict calls and to restore factory settings. The default security code is 12345. Use **Menu 4 3 2 4** to change the security code.

When the phone requires the security code, it displays **Security code:**. Enter the code, then press **OK**.

If you enter an incorrect security code five times in succession, the phone will not accept any input for the next five minutes.

Restricting calls

Use **Menu 4 3 1** to restrict outgoing or incoming calls. This is handy if you want to lend your phone to someone but don't want them to make long-distance or other expensive calls.

Restricting incoming calls

You can block all incoming calls or create a list of incoming numbers from which you don't want to receive calls. To block all incoming calls, enter your security code, scroll to **Select** and press **OK**, then press **Mark**.

Press **Unmark** if you want to remove the restriction.

Press **C**, then press **Yes** to save your changes (or **C** to cancel).

Note: This feature requires the caller ID network service, and the caller's ID must be available to the phone in order for the restriction to work.

Adding numbers to the restricted incoming calls list

A call restriction can consist of an entire phone number, just an area code, etc. When the restriction is selected, calls cannot be received from any number beginning with those digits. For example, entering **2145551234** blocks calls from (214) 555-1234 only. **214** blocks all calls from the 214 area code.

To create a list of incoming numbers from which you don't want to receive calls, enter your security code, then press **OK**. Continue with the steps illustrated below.

- 1 Scroll to **Add restriction**, then press **OK**.

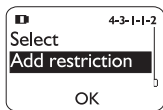

- 2 Enter the phone number, area code, etc. of the number from which you want to restrict calls, then press **OK**.

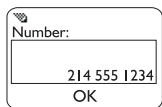

- 3 If you want, give a name of up to 10 characters to the restriction (such as **Joey**), then press **OK**.

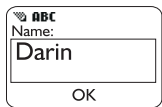



The entry is added to your list of restricted numbers. Your phone can save up to 15 restricted incoming numbers. Once you enter 15 restricted numbers, the **Add restriction** option is removed from the menu. This option is available again once you delete one or more phone numbers from the restricted list.

Note: Your phone does not alert you to incoming calls from restricted numbers unless the caller leaves a voice message.

Making changes to the restricted incoming calls list

To edit or completely erase an entry in the list, choose **Edit** or **Erase**, select the entry you want to edit or erase, and follow the instructions on the screen.

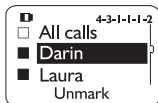

Allowing calls from a number on the list

If you later decide to allow calls to a restricted number, scroll to **Select** and press **OK** to see your list of numbers. Press **Unmark** to remove the restriction. (The number remains in the list so that you can restrict it again later by pressing **Mark**.) When you're done, press . Press **Yes** to save your changes (or  to cancel).



Restricting outgoing calls

You can block all outgoing calls or create a list of numbers to which outgoing calls cannot be made. To block all outgoing calls,

- 1 Enter your security code and press **OK**.
- 2 Scroll to **Select** and press **OK**.
- 3 With **All calls** highlighted, press **Mark**.
- 4 Press , then press **Yes** to save your changes (or  to cancel).

Adding numbers to the restricted outgoing calls list

A call restriction can consist of an entire phone number, an area code, etc. When the restriction is selected, calls cannot be made to any number beginning with those digits. For example, entering **2145551234** blocks calls to (214) 555-1234 only. **1** blocks all calls starting with 1, including long distance calls and 1-800 calls. **1800** blocks 1-800 calls only.

To prevent your phone from making outgoing calls, scroll to **Add restriction** and press **OK**. Continue with the steps illustrated below.

- 1 Scroll to **Add restriction**, then press **OK**.



- 2 Enter the phone number, area code, etc. to which you want to restrict calls, then press **OK**.

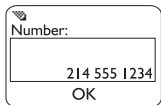

- 3 If you want, give a name of up to 10 characters to the restriction (such as **Joey, Long dist,** or **1-800 #s**), then press **OK**.

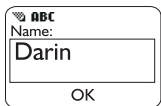

The entry is added to your list of restricted numbers. Your phone can save up to 10 restricted outgoing numbers. Once you enter 10 restricted numbers, the **Add restriction** option is removed from the menu. This option is available again once you delete one or more phone numbers from the restricted list.

Making changes to the restricted outgoing calls list

To edit or completely erase an entry in the list, choose **Edit** or **Erase**, select the entry you want to edit or erase, and follow the instructions on the screen.

Allowing calls to a number on the list

If you later decide to allow calls to a restricted number, scroll to **Select** and press **OK**. You can now see your list of numbers. Press **Unmark** to remove the restriction. (The number remains in the list so that you can restrict it again later by pressing **Mark**.) When you're done, press **C**. Press **Yes** to save your changes (or **C** to cancel).

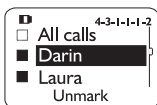

Phone lock

You can prevent unauthorized use of your phone by locking it. When your phone is locked, only incoming calls and calls to the unlocked phone number (see below) are allowed. The memory and menu are unavailable.

Note: Calls may still be possible to emergency numbers.

How to lock your phone

Press **Menu** 4 3 2 1. Enter the lock code (see page 51), then press **OK**. Scroll to **On**, then press **OK**.

How to unlock your phone

Press **Menu**, enter the lock code, then press **OK**.

Answering a call when the phone is locked

Press **Answer**.

Saving the unlocked phone number

Use **Menu** 4 3 2 2 to save a number that may be called even when your phone is locked. You are required to enter the lock code.

Calling the unlocked phone number

Press **V** or **^**, or manually enter the number exactly as it is saved, then press **Call**.

14. Accessories

An extensive range of accessories is available for your phone. You can select the accessories that best suit your specific communication needs. For availability, see your local authorized Nokia dealer.



A few practical rules for accessory operation:

- Keep accessories out of small children's reach.
- When you disconnect the power cord of any accessory, grasp and pull the plug, not the cord.
- Check regularly that all wireless phone equipment in your vehicle is mounted and operating properly.
- Installation of complex car equipment must be completed by qualified personnel only.

WARNING!

Use only batteries, chargers and accessories approved by the phone manufacturer for use with this particular phone model. The use of any other types may invalidate any approval or warranty applying to the phone, and may be dangerous.

Nokia Xpress-on™ color covers

Your phone's Xpress-on™ cover is available in several fashion colors. Extra covers may be purchased from your authorized Nokia dealer.

Note: Always store your phone with the cover attached.

Changing covers

When changing covers, don't use the phone's antenna as leverage!

- 1 Switch off the power and disconnect the phone from the charger or any other device.
- 2 Using a coin, depress the colored tab on the top of the phone and slide the color cover forward.



- 3 Remove the cover.



- 4 Remove the rubber keypad from the back of the cover. Place it into the back of the new cover.

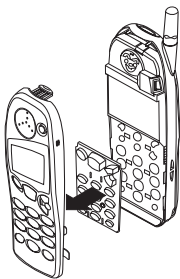

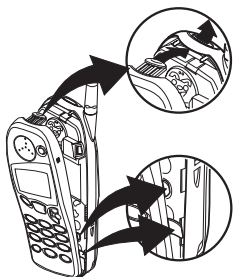

- 5 Place the bottom of the cover against the bottom of the phone. Make sure all three sets of plastic tabs line up with their respective slots, as shown at left. Close the cover and snap it shut all the way around the edge of the phone.

Batteries

Several batteries are available for your phone:

- BLS-2 Extended Li-Ion 900 mAh
- BMS-2S Extended NiMH 900 mAh
- BMS-2V Vibrating NiMH 900 mAh
- BLS-4 Ultra Extended Li-Ion 1500 mAh

Charging times

The table below displays approximate battery charging times. These charging times charge your phone to about 80% of its capacity, and the battery strength indicator stops scrolling. If you wish to obtain 100% battery capacity, please allow another two hours for "maintenance" charge.

Battery	Standard Travel Charger ACP-7U	Rapid Travel Charger ACP-9U	Rapid Cig. Lighter Charger LCH-9
BLS-2 Extended Li-Ion 900 mAh	4 hours	2 hours	
BMS-2S Extended NiMH 900 mAh		1.5 hours	
BMS-2V Vibrating NiMH 900 mAh			
BLS-4 Ultra Extended Li-Ion 1500 mAh	5 hours	3.5 hours	

Talk and standby times

The table below displays approximate talk and standby times. Variations occur depending on network settings and usage.

Battery	Talk Time	Standby Time
	Digital	Digital
BLS-2 Extended Li-Ion 900 mAh	2 hrs, - 2 hrs, 55 min	70 hrs - 110 hrs
BMS-2S Extended NiMH 900 mAh		
BMS-2V Vibrating NiMH 900 mAh		
BLS-4 Ultra Extended Li-Ion 1500 mAh	3 hrs, 20 min - 4 hrs, 50 min	115 hrs - 180 hrs

Chargers and other accessories

WARNING!

This apparatus is intended for use when supplied with power from the Standard Travel Charger (ACP-7U), Rapid Travel Charger (ACP-9U), or Rapid Cigarette Lighter Charger (LCH-9). Other usage will invalidate any approval given to this apparatus and may be dangerous.

The following chargers and other accessories are available for your phone; please see your dealer for details. Also, refer to any accessory options manual that may have been included in your sales package for the entire line of Nokia Original Accessories.

Note: When a charger is not in use, disconnect it from the power source. Do not leave the battery connected to a charger for longer than a week, since overcharging may shorten its life. If left unused, a fully charged battery will discharge itself over time.

ACP-7U Standard Travel Charger

Use this durable and economical charger to charge all battery options. Plug the charger into a wall outlet and connect the connector to the bottom of your phone. Check the charging status on your phone's screen.

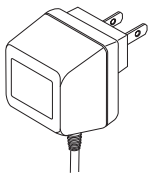

Calls can be made during charging, but charging will stop for the duration of the call and the battery bar scrolling stops.

Note: If the battery is completely empty, you cannot use the phone until it has enough charge to operate.

The Standard Travel Charger is available for different voltage levels and can also be used with the DCH-9 Compact Desktop Charging Stand.

ACP-9U Rapid Travel Charger

The extremely light, functionally designed Rapid Travel Charger charges your phone battery quickly.

Plug the charger into a wall outlet and connect the connector to the bottom of your phone. Check the charging status on your phone's screen. You can use your phone while charging.

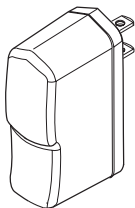

Operating within a voltage range of 100V-240V AC (50Hz-60Hz), the Rapid Travel Charger is practically voltage-independent in normal office and household use. Like the Standard Travel Charger, the Rapid Travel Charger is compatible with all battery options. The Rapid Travel Charger can also be used with the DCH-9 Compact Desktop Charging Stand.

LCH-9 Rapid Cigarette Lighter Charger

Using the multivoltage Rapid Cigarette Lighter Charger, you can charge your phone when you travel. The small charger's functional design fits well with most car lighters and interiors.

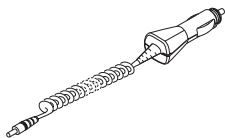

Charging times are the same as for the Rapid Travel Charger ACP-9U. Calls can be made during charging.

A green light indicates that the Rapid Cigarette Lighter Charger is ready to charge. Check the charging status on your phone's screen. The input voltage is 12 or 24 V DC, negative grounding.

The Rapid Cigarette Lighter Charger can be used with all accessories available for your phone.

Avoid prolonged charging with the Rapid Cigarette Lighter Charger when the car engine is not running. This may cause the battery of your car to drain.

Note: In some cars the cigarette lighter plug is not provided with power when the ignition is switched off. Verify that the green LED light is lit.

DCH-9 Compact Desktop Charging Stand

Compatible with all battery options, the Compact Desktop Charging Stand can be used with the Standard Travel Charger ACP-7U or the Rapid Travel Charger ACP-9U. The

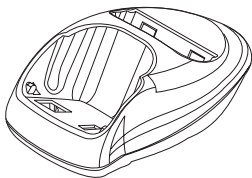

Compact Desktop Charging Stand provides mounting for both the phone and a spare battery. Plug the charger into a wall outlet and connect the connector to the back of the Compact Desktop Charging Stand. Place your phone and/or a spare battery in the stand to begin battery charging.

When the phone is charging, no lights are displayed on the stand; check the charging status of the phone battery on your phone's screen.

Charging moves to the rear slot once the front battery is 100% charged.

When the spare battery is charging, check the status indicator on the left side of the charging stand. A red light indicates that the battery is charging; a green light indicates that the battery is charged to at least 80% of its capacity.

DCH-9 Rear Slot Charging Times				
Battery	Using ACP-7U		Using ACP-9U	
	Front slot empty	Front slot occupied	Front slot empty	Front slot occupied
BLS-2 Extended Li-Ion 900 mAh	6 hours, 30 minutes	8 hours, 30 minutes	4 hours, 30 minutes	5 hours, 30 minutes
BMS-2S Extended NiMH 900 mAh				
BMS-2V Vibrating NiMH 900 mAh				
BLS-4 Ultra Extended Li-Ion 1500 mAh	12 hours	15 hours, 45 minutes	8 hours	10 hours, 30 minutes

The phone has the built-in intelligence to maintain the battery, so there is no need for a discharge feature on the stand.

15. Reference information

Important safety information

Traffic safety

Do not use a hand-held telephone while driving a vehicle. If using a hand-held phone park the vehicle before conversing. Always secure the phone in its holder; do not place the phone on the passenger seat or where it can break loose in a collision or sudden stop.

The use of an alert device to operate a vehicle's lights or horn on public roads is not permitted.

Remember, road safety always comes first!

Operating environment

Remember to follow any special regulations in force in any area and always switch off your phone whenever it is forbidden to use it, or when it may cause interference or danger.

When connecting the phone or any accessory to another device, read its user's guide for detailed safety instructions. Do not connect incompatible products.

As with other mobile radio transmitting equipment, users are advised that for the satisfactory operation of the equipment and for the safety of personnel, it is recommended that the equipment should only be used in the normal operating position (held to your ear with the antenna pointing over your shoulder).

Electronic devices

Most modern electronic equipment is shielded from radio frequency (RF) signals. However, certain electronic equipment may not be shielded against the RF signals from your wireless phone.

Pacemakers

Pacemaker manufacturers recommend that a minimum separation of 6 inches (20 cm.) be maintained between a handheld wireless phone and a pacemaker to avoid potential interference with the pacemaker. These recommendations are consistent with the independent research by and recommendations of Wireless Technology Research.

Persons with pacemakers:

- Should always keep the phone more than 6 inches (20 cm) from their pacemaker when the phone is switched on;
- Should not carry the phone in a breast pocket;
- Should use the ear opposite the pacemaker to minimize the potential for interference.
- If you have any reason to suspect that interference is taking place, switch off your phone immediately.

Hearing aids

Some digital wireless phones may interfere with some hearing aids. In the event of such interference, you may want to consult your service provider.

Other medical devices

Operation of any radio transmitting equipment, including cellular phones, may interfere with the functionality of inadequately protected medical devices. Consult a physician or the manufacturer of the medical device to determine if they are adequately shielded from external RF energy or if you have any questions. Switch off your phone in health care facilities when any regulations posted in these areas instruct you to do so. Hospitals or health care facilities may be using equipment that could be sensitive to external RF energy.

Vehicles

RF signals may affect improperly installed or inadequately shielded electronic systems in motor vehicles (e.g. electronic fuel injection systems, electronic anti-skid (anti-lock) braking systems, electronic speed control systems, air bag systems). Check with the manufacturer or its representative regarding your vehicle. You should also consult the manufacturer of any equipment that has been added to your vehicle.

Posted facilities

Switch your phone off in any facility where posted notices so require.

Potentially explosive atmospheres

Switch off your phone when in any area with a potentially explosive atmosphere and obey all signs and instructions. Sparks in such areas could cause an explosion or fire resulting in bodily injury or even death.

Users are advised to switch off the phone while at a refueling point (service station). Users are reminded of the need to observe restrictions on the use of radio equipment in fuel depots (fuel storage and distribution areas), chemical plants or where blasting operations are in progress.

Areas with a potentially explosive atmosphere are often but not always clearly marked. They include below deck on boats; chemical transfer or storage facilities; vehicles using liquefied petroleum gas (such as propane or butane); areas where the air contains chemicals or particles, such as grain, dust or metal powders; and any other area where you would normally be advised to turn off your vehicle engine.

Vehicles

Only qualified personnel should service the phone, or install the phone in a vehicle. Faulty installation or service may be dangerous and may invalidate any warranty which may apply to the unit.

Check regularly that all wireless phone equipment in your vehicle is mounted and operating properly.

Do not store or carry flammable liquids, gases or explosive materials in the same compartment as the phone, its parts or accessories.

For vehicles equipped with an air bag, remember that an air bag inflates with great force. Do not place objects, including both installed or portable wireless equipment, in the area over the air bag or in the air bag deployment area. If in-vehicle wireless equipment is improperly installed and the air bag inflates, serious injury could result.

Switch off your phone before boarding an aircraft. The use of wireless telephones in an aircraft may be dangerous to the operation of the aircraft, disrupt the wireless telephone network and may be illegal.

Failure to observe these instructions may lead to the suspension or denial of telephone services to the offender, or legal action, or both.

Emergency calls

IMPORTANT!

This phone, like any wireless phone, operates using radio signals, wireless and landline networks as well as user-programmed functions which cannot guarantee connection in all conditions. Therefore, you should never rely solely upon any wireless phone for essential communications (e.g. medical emergencies).

Remember, to make or receive any calls the phone must be switched on and in a service area with adequate signal strength. Emergency calls may not be possible on all wireless phone networks or when certain network services and/or phone features are in use. Check with local service providers.

Making an emergency call

- 1 If the phone is not on, switch it on.
- 2 Press and hold  for several seconds to ready the phone for calls.
- 3 Key in the emergency number for your present location (e.g. 911 or other official emergency number). Emergency numbers vary by location.
- 4 Press **Call**

If certain features are in use (Keyguard, call restrictions, etc.), you may first need to turn those features off before you can make an emergency call. Consult this document and your local cellular service provider.

When making an emergency call, remember to give all the necessary information as accurately as possible. Remember that your wireless phone may be the only means of communication at the scene of an accident - do not cut off the call until given permission to do so.

Radio frequency (RF) signals

Your wireless handheld portable telephone is a low power radio transmitter and receiver. When it is ON, it receives and also sends out radio frequency (RF) signals.

In August, 1996, the Federal Communications Commission (FCC) adopted RF exposure guidelines with safety levels for handheld wireless phones. Those guidelines are consistent with safety standards previously set by both U.S. and international standards bodies:

ANSI C95.1 (1992)*, NCRP Report 86 (1986)*, ICNIRP (1996)*.

Those standards were based on comprehensive and periodic evaluations of the relevant scientific literature. For example, over 120 scientists, engineers, and physicians from universities, government health agencies and industry reviewed the available body of research to develop the ANSI Standard (C95.1).

The design of your phone complies with the FCC guidelines (and those standards).

**American National Standards Institute, National Council on Radiation Protection and Measurements; International Commission on Non-Ionizing Radiation Protection.*

Care and maintenance

Your phone is a product of superior design and craftsmanship and should be treated with care. The suggestions below will help you to fulfill any warranty obligations and allow you to enjoy this product for many years. When using your phone, battery, charger, OR any accessory:

- Keep it and all its parts and accessories out of small children's reach.
- Keep it dry. Precipitation, humidity and liquids contain minerals that will corrode electronic circuits.
- Do not use or store it in dusty, dirty areas as its moving parts can be damaged.
- Do not store it in hot areas. High temperatures can shorten the life of electronic devices, damage batteries, and warp or melt certain plastics.
- Do not store it in cold areas. When the phone warms up (to its normal operating temperature), moisture can form inside the phone, which may damage the phone's electronic circuit boards.
- Do not attempt to open it. Non-expert handling of the device may damage it.
- Do not drop, knock or shake it. Rough handling can break internal circuit boards.
- Do not use harsh chemicals, cleaning solvents, or strong detergents to clean it. Wipe it with a soft cloth slightly dampened in a mild soap-and-water solution.
- Do not paint it. Paint can clog the device's moving parts and prevent proper operation.
- Use only the supplied or an approved replacement antenna. Unauthorized antennas, modifications or attachments could damage the phone and may violate regulations governing radio devices.
- If the phone, battery, charger, or any accessory is not working properly, take it to your nearest qualified service facility. The personnel there will assist you, and if necessary, arrange for service.

16. Technical information

Transmitting power:	230mW to 275mW EIRP
Operating voltage:	3.6 V nominal
Frequency band:	1850.04 - 1909.92 MHz (TX) 1930.08 - 1989.96 MHz (RX)
Number of channels:	1151 highband
Number of NAMs	1
Memory locations:	100
Memory capacity:	16 characters per name 32 characters per number

USA

Nokia Mobile Phones

6200 Courtney Campbell Causeway, Ste. 900

Tampa, FL 33607

Tel: 1-888-NOKIA2U (1-888-665-4228)

TTY Users: 1-800-24NOKIA (1-800-246-6542)

CANADA

Nokia Products Ltd.

575 Westney Rd. South

Ajax, Ontario L1S 4N7

Tel: (905) 427-6654

Part No. 9352054

Printed in Canada

04/99

Nokia, Connecting People and the Original Accessories logos are trademarks of Nokia Corporation and/or its affiliates.

The information contained in this User Guide was written for Nokia phone NSD-1FX.

The right to make changes and improvements to any of the products described in this guide without prior notice is reserved.

Issue No. 1 © 1998 Nokia Mobile Phones. All rights reserved.

These commodities are authorized by the U.S. Government for export only to Canada, Mexico, or the United States. They may not be resold, diverted, transferred, or otherwise disposed of in any other country, either in their original form or after being incorporated through an intermediate process into other end-items, without the written approval of the U.S. Department of State.

17. One-Year Limited Warranty

Nokia Mobile Phones, Inc. ("NMP") warrants that this cellular phone ("Product") is free from defects in material and workmanship that result in Product failure during normal usage, according to the following terms and conditions:

1. The limited warranty for the Product extends for ONE (1) year beginning on the date of the purchase of the Product.
2. The limited warranty extends to the original purchaser of the Product ("Consumer") and is not assignable or transferable to any subsequent purchaser/end-user.
3. The limited warranty extends only to Consumers who purchase the Product in the United States.
4. During the limited warranty period, NMP will repair, or replace, at NMP's option, any defective parts, or any parts that will not properly operate for their intended use with new or factory rebuilt replacement items if such repair or replacement is needed because of product malfunction or failure during normal usage. No charge will be made to the Consumer for any such parts. NMP will also pay for the labor charges incurred by NMP in repairing or replacing the defective parts. The limited warranty does not cover defects in appearance, cosmetic, decorative or structural items, including framing, and any non-operative parts. NMP's limit of liability under the limited warranty shall be the actual cash value of the Product at the time the Consumer returns the Product for repair, determined by the price paid by the Consumer for the Product less a reasonable amount for usage. NMP shall not be liable for any other losses or damages. These remedies are the Consumer's exclusive remedies for breach of warranty.
5. Upon request from NMP, the Consumer must prove the date of the original purchase of the Product by a dated bill of sale or dated itemized receipt.
6. The Consumer shall bear the cost of shipping the Product to NMP in Melbourne, Florida. NMP shall bear the cost of shipping the Product back to the Consumer after the completion of service under this limited warranty.
7. The Consumer shall have no coverage or benefits under this limited warranty if any of the following conditions are applicable:
 - a) The Product has been subject to abnormal use, abnormal conditions, improper storage, exposure to moisture or dampness, unauthorized modifications, unauthorized connections, unauthorized repair, misuse, neglect, abuse, accident, alteration, improper installation, or other acts which are not the fault of NMP, including damage caused by shipping.

b) The Product has been damaged from external causes such as collision with an object, or from fire, flooding, sand, dirt, windstorm, lightning, earthquake or damage from exposure to weather conditions, an Act of God, or battery leakage, theft, blown fuse, or improper use of any electrical source, or damage caused by the connection to other products not recommended for interconnection by NMP.

c) NMP was not advised by the Consumer in writing of the alleged defect or malfunction of the Product within fourteen (14) days after the expiration of the applicable limited warranty period.

d) The Product serial number plate or the accessory data code has been removed, defaced or altered.

e) The defect or damage was caused by the defective function of the cellular system or by inadequate signal reception by the external antenna.

8. If a problem develops during the limited warranty period, the Consumer shall take the following step-by-step procedure:

a) The Consumer shall return the Product to the place of purchase for repair or replacement processing.

b) If "a" is not convenient because of distance (more than 50 miles) or for other good cause, the Consumer shall ship the Product prepaid and insured to:

Nokia Mobile Phones, Inc.
Attn: Repair Department
795 West Nasa Blvd.
Melbourne, FL 32901

c) The Consumer shall include a return address, daytime phone number and/or fax number, complete description of the problem, proof of purchase and service agreement (if applicable). Expenses related to removing the Product from an installation are not covered under this limited warranty.

d) The Consumer will be billed for any parts or labor charges not covered by this limited warranty. The Consumer will be responsible for any expenses related to reinstallation of the Product.

e) NMP will repair or authorize the repair of the Product under the limited warranty within 30 days after receipt of the Product by NMP or an NMP authorized service center. If NMP cannot perform repair covered under this limited warranty within 30 days, or after a reasonable number of attempts to repair the same defect, NMP at its option, will provide a replacement Product or refund the purchase price of the Product less a reasonable amount for usage.

f) If the Product is returned to NMP during the limited warranty period, but the problem with the Product is not covered under the terms and conditions of this limited warranty, the Consumer will be notified and given an estimate of the charges the Consumer must pay to have the Product repaired, with all shipping charges billed to the Consumer. If the estimate is refused, the Product will be returned freight collect. If the Product is returned to NMP after the expiration of the limited warranty period, NMP's normal service policies shall apply and the Consumer will be responsible for all shipping charges.

9. The Product consists of newly assembled equipment that may contain used components that have been reprocessed to allow machine compliance with Product performance and reliability specifications.

10. ANY IMPLIED WARRANTY OF MERCHANTABILITY, OR FITNESS FOR A PARTICULAR PURPOSE OR USE, SHALL BE LIMITED TO THE DURATION OF THE FOREGOING LIMITED WRITTEN WARRANTY. OTHERWISE, THE FOREGOING LIMITED WARRANTY IS THE CONSUMER'S SOLE AND EXCLUSIVE REMEDY AND IS IN LIEU OF ALL OTHER WARRANTIES, EXPRESS OR IMPLIED. NMP SHALL NOT BE LIABLE FOR SPECIAL, INCIDENTAL OR CONSEQUENTIAL DAMAGES, INCLUDING BUT NOT LIMITED TO, LOSS OF ANTICIPATED BENEFITS OR PROFITS, LOSS OF SAVINGS OR REVENUE, PUNITIVE DAMAGES, LOSS OF USE OF THE PRODUCT OR ANY ASSOCIATED EQUIPMENT, COST OF CAPITAL, COST OF ANY SUBSTITUTE EQUIPMENT OR FACILITIES, DOWNTIME, THE CLAIMS OF ANY THIRD PARTIES, INCLUDING CUSTOMERS, AND INJURY TO PROPERTY, RESULTING FROM THE PURCHASE OR USE OF THE PRODUCT OR ARISING FROM BREACH OF THE WARRANTY, BREACH OF CONTRACT, NEGLIGENCE, STRICT TORT, OR ANY OTHER LEGAL OR EQUITABLE THEORY, EVEN IF NMP KNEW OF THE LIKELIHOOD OF SUCH DAMAGES. NMP SHALL NOT BE LIABLE FOR DELAY IN RENDERING SERVICE UNDER THE LIMITED WARRANTY, OR LOSS OF USE DURING THE PERIOD THAT THE PRODUCT IS BEING REPAIRED.

11. Some states do not allow limitation of how long an implied warranty lasts, so the above one-year warranty limitation may not apply to you (the Consumer). Some states do not allow the exclusion or limitation of incidental and consequential damages, so certain of the above limitations or exclusions may not apply to you (the Consumer). This limited warranty gives the Consumer specific legal rights and the Consumer may also have other rights which vary from state to state.

12. NMP neither assumes nor authorizes any authorized service center or any other person or entity to assume for it any other obligation or liability beyond that which is expressly provided for in this limited warranty including the provider or seller of any extended warranty or service agreement.

13. This is the entire warranty between NMP and the Consumer, and supersedes all prior and contemporaneous agreements or understandings, oral or written, and all communications relating to the Product, and no representation, promise or condition not contained herein shall modify these terms.

14. This limited warranty allocates the risk of failure of the Product between the Consumer and NMP. The allocation is recognized by the Consumer and is reflected in the purchase price of the Product.

15. Any action or lawsuit for breach of warranty must be commenced within eighteen (18) months following delivery of the Product.

16. Questions concerning this limited warranty may be directed to:

Nokia Customer Service

6200 Courtney Campbell Causeway, Ste. 900

Tampa, FL 33607

Telephone: 1-888-NOKIA2U (1-888-665-4228)

or (813) 288-3800

Facsimile: (813) 287-6612

TTY Users: 1-800-24NOKIA (1-800-246-6542)

17. The limited warranty period for NMP supplied attachments and accessories is specifically defined within their own warranty cards and packaging.

*Nokia is a registered trademark of Nokia Corporation.

18. Index

A

- ABC mode 11
- accessories 56
 - batteries 59
 - chargers 60
 - covers 56
- alarm clock 48
- answering a call 17
 - automatic answer 39
- antenna 15
 - external jack 8
- automatic answer 39

B

- batteries 59
 - attaching 3
 - charging 3
 - discharging 4
 - removing 4
- blocking calls see restricting calls

C

- C key 7
- call block see restricting calls
- call forwarding
 - activating 35
 - cancelling 35
- call log 41
 - clearing lists 42
 - dialed calls 42
 - missed calls 41
 - Options key 41
 - received calls 42
- call restrictions see restricting calls
- call timers 42

- call waiting 32
 - answering a waiting call 32
 - cancelling 32
- caller ID 18
 - showing/hiding number 37
- calling card
 - making calls 34
 - set-up 33
- calls
 - answering 17
 - answering automatically 39
 - answering with call waiting 32
 - ending 32
 - forwarding 34
 - initiating a second 31
 - making 16
 - muting 16, 31
 - silencing an incoming call 18
 - unmuting 16
 - unmuting the microphone 31
- care and maintenance 68
- chargers 60
- clearing call lists 42
- clock 22
 - alarm clock 48
 - displaying/hiding 23
 - setting 22
 - time format 23
- Compact Desktop Charging Stand 62
- covers, changing 56
- cursor 11

D

- dialed calls 42
- directory see phone book 19

E

- editing names/numbers 20
- emergency calls 28, 66
- emergency key 9 29
- erasing names/numbers 21
- external antenna jack 8

F

- factory settings, restoring 40

G

- games 49

H

- help text 8

I

- Inbox 47
- in-call menu 31

K

- Keyguard 13
- keypad lock 13
- keys
 - clear key 7
 - Navi(TM) key 6
 - power key 6
 - scroll keys 7

L

- language 23
- lights 7
 - in car kit 23
- lock code 51
- locking the keypad 13
- locking your phone 55

M

- making a call 16
- memory 21
- menu 8
 - shortcuts 9

- messages
 - text see text messages
 - voice mail 44
- missed calls 41
- muting the microphone 16, 31

N

- NAM selection 37
- names
 - editing 20
 - entering 11
 - erasing 21
 - finding 17, 20
 - saving 19
- Navi(TM) key 6
- network feature setting 30
- new call 31
- numbers
 - editing 20
 - entering 12
 - erasing 21
 - finding 17, 20
 - saving 19
 - showing/hiding your own 37

O

- on/off 15
- one-touch dialing 36

P

- phone book 19
 - available memory 21
 - scrolling view 21
- phone lock 55
- phone number, choosing see NAM selection
- power key 6
- profiles see quick alert settings

Q

quick alert settings 25

R

Rapid Cigarette Lighter
Charger 62

Rapid Travel Charger 61

reading text messages 46

received calls 42

redial

automatic 22

last number 17

restore factory settings 40

restricting calls 51

ringing see tones

S

safety guidelines 1, 64

safety information 64

Saved folder 47

scroll keys 7

scrolling view 21

security code 51

security features 51

send own number 37

signal strength 16

silencing an incoming call 18

sound see tones

special characters 12

speed dialing see one-touch
dialing

Standard Travel Charger 61

system selection 39

T

technical information 69

text messages 46

Inbox 47

reading 46

Saved folder 47

storage 47

timers 42

tones 23

keypad 25

message alert 25

quick alert settings 25

ringing option 24

ringing tone 24

ringing volume 24

warning and game 25

touch tones 39

saving touch tone strings 40

setting automatic length 40

setting manual length 39

TTY contact information 69

U

unmuting the microphone
16, 31

V

vibrating alert 25

voice mail messages 44

voice mailbox number 26

volume

earpiece 16

ringing 24

W

warranty 70

welcome note 27

NOTES

NOTES

Para obtener un manual del usuario en español favor de llamar o enviar un fax al teléfono 1-888-NOKIA2U (1-888-665-4228), fax 813-287-6612.
