

NOKIA

CONNECTING PEOPLE



**OWNER'S
MANUAL**

**NOKIA
918**



Description of Keys

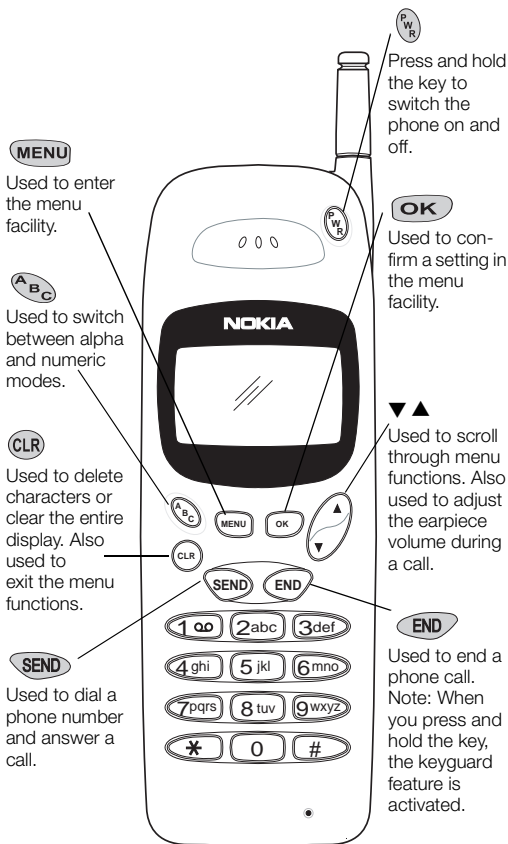

Quick Guide

NOKIA
918

- Making a call Key in the area code and phone number and press the **SEND** key
- Receiving a call Press any key except the **PWR** key
- Switching on/off Press and hold the **PWR** key
- Activate Keyguard Press and hold the **END** key or Press **MENU** then *****
- Deactivate Keyguard Press **MENU** then *****
- Activate PINCALL Key in ***** **#** P I N C A L L **#** then enter PIN Code and then press the **MENU** key
- Deactivate PINCALL Key in ***** **#** P I N C A L L **#** then press the **OK** key
- Adjust Volume Press **▲** to increase and **▼** to decrease the volume (in a call)
- Calling Card Call Enter destination phone number and press and hold the **SEND** key for more than 1 second
- Clear a digit Press the **CLR** key
- Clear display Press and hold the **CLR** key
- Ending a Call Press the **END** key
- Last number redial Ensure the display is clear and press **SEND** **SEND**
- Last 10 dialed numbers Ensure the display is clear and press **SEND**. Press **▼** to view dialed numbers. Press **SEND** to dial

Memory Functions

- 9 Key Emergency Call Press and hold the **9_{wxyz}** key for more than 4 seconds
- (**Note:** Emergency dialing menu must be set to on)
- One-Touch dialing Press and hold the **1₀₀** key for a few seconds
- Storing a number Ensure the display is clear, enter area code and number. Press the **A_{BC}** key to enter a name. Press and hold the **OK** key
- Search for a name With a clear display, press the **A_{BC}** key then **▼**

Search for a number Press ▼ key to scroll through stored numbers

Speed dialing Press a location number (1-40) and then **SEND**

The Menu Facility

Enter menu facility Press the **MENU** key

Enter function Press the **OK** key

Exit menu facility Press the **CLR** key

Menu shortcut (For Menus 1-9) Press the **MENU** key and then the Menu number

Scroll Press ▼ to scroll forward and ▲ to scroll backward

Select option Press the **OK** key

To Activate Calling Card (Menu 13)

Card Type	Includes these cards	Uses this U.S.A. access number
A	Sprint MCI PacBell	1-800-877-8000 1-800-950-1022 1-800-555-5321
B	MCI MCI GTE	1-800-888-8000 1-800-674-0700 1-800-225-5483
C	AT&T Sprint PacBell	1-800-225-5288 1-800-277-7468 1-800-522-2020
D	AT&T10 Sprint Ameritech	10288 10333 (press OK at ACCESS NUMBER? prompt)
E	MCI	1-800-999-9000

Contents

1. For Your Safety	1
Making Calls	2
Emergency Calls.	2
Regulations	2
2. Battery and Signal	3
To Install the Battery	3
To Remove the Battery	3
To Charge the Battery	4
To Discharge the Battery	5
Important Battery Information	6
Signal Strength Indication	7
3. The Basics.	8
Switching On/Off	8
Making a Call	8
Ending a Call	9
Answering a Call	9
Adjusting the Earpiece Volume	10
Last Number Redial	10
Speed Dialing	11
1 Touch Dialing	11
Using Your Voice Mailbox	11
9 Key Emergency Dialing	12
Keyguard	12
Calling Card Call	13
PIN Call	14
What is Prepaid Mode?	15
4. The Phone Directory	16
Alpha Mode.	16
To Store Numbers and Names	17
To Erase Stored Names and Numbers . .	20
To Recall Stored Numbers.	21
To Recall Stored Names	21

5. The Menu	22
Accessing Menus by Number	22
List of Menu Functions	23
Menu 1, Store To Memory	24
Menu 2, Find Name	24
Menu 3, Erase Name	24
Menu 4, Restrict Calls	24
Menu 5, System Select	25
Menu 6, Call Timers	27
Menu 7, Lights	28
Menu 8, Keypad Tones	29
Menu 9, Ringing Volume	30
Menu 10, Ringing Type	30
Menu 11, Emergency Key 9	31
Menu 12, NAM Select	31
Menu 13, Calling Card	32
Menu 14, Change Lockcode	34
Menu 15, Call Register	34
Menu 16, Debit (prepaid only)	35
6. Additional Features	40
Sending DTMF (“Touch”) Tones	40
7. Accessories	42
8. Reference Information	52
Important Safety Information	52
Care and Maintenance	55
Troubleshooting	56
Technical Information	57
Nokia 1-Year Limited Warranty . .	58

1. For Your Safety



Read these simple guidelines before using your phone. Failure to comply with these guidelines may be dangerous or illegal.

For more detailed safety information, see “Important Safety Information” on page 52.



Road Safety Comes First

Don't use a hand-held phone while driving; park the vehicle first.



Switch Off In Hospitals

Switch off your phone when near medical equipment. Follow any regulations or rules in force.



Switch Off On Aircraft

Mobile phones can cause interference. Using them on aircraft is illegal.



Switch Off When Refueling

Do not use the phone at a refueling point. Do not use near fuels or chemicals.



Switch Off Near Blasting

Do not use the phone where a blasting operation is in progress. Observe restrictions, and follow any regulations or rules in force.



Use Sensibly

Use only in the normal position (to ear). Avoid unnecessary contact with the antenna when phone is on.



Interference

All mobile phones may be subject to radio interference, which may affect the performance of the phone. Therefore, you should never rely solely upon any cellular phone for essential communications (e.g., medical emergencies).



Qualified Service

Only qualified service personnel may install or repair cellular phone equipment. Use only approved accessories and batteries.

Making Calls

- 1) Switch the phone on and make sure it is in service.
- 2) Enter the **phone number** including area code then press **SEND**. To end a call press **END**. To answer a call press **SEND**.

Emergency Calls

- 1) Switch the phone on. Make sure it is on and in service.
- 2) Press and hold **CLR** to clear the display. Enter the emergency number (e.g. 911) and press **SEND**. Give your location. Do not end the call until given permission to do so.

See “9 Key Emergency Dialing” on page 12.

Regulations

FCC/Industry Canada Notice

A cellular phone may cause TV or radio interference (e.g., when using a phone in close proximity to electronic receiving equipment). The FCC/Industry Canada can require you to stop using your cellular phone if such interference cannot be eliminated. If you require assistance, please contact your local service facility.

This device complies with part 15 of the FCC rules. Operation is subject to the condition that this device does not cause harmful interference.

The cellular phone described in this guide is approved for use in AMPS networks.

2. Battery and Signal

Your phone is powered by a rechargeable battery. Use only batteries approved by the phone manufacturer and recharge your battery only with the chargers approved by the manufacturer. See “Important Battery Information” on page 6.



A new battery must be fully charged before being used for the first time. A new battery's full performance is achieved only after two or three complete charge and discharge cycles!

To Install the Battery

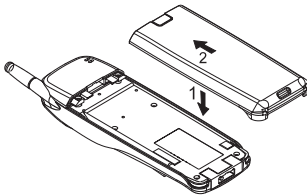

To Remove the Battery

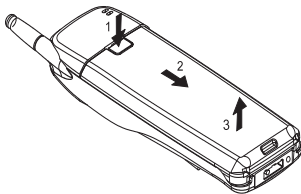

Switch off the power before removing the battery.

To Charge the Battery

Plug the charger into a standard AC wall outlet then connect the connector to the bottom of your phone.

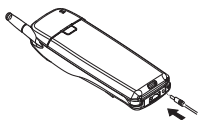

When charging starts the battery segments scroll and the phone beeps once.

You can use the phone during the charging, but the charging will be reduced for the duration of the call. Note that if the battery is completely empty and you are using the Standard Travel Charger (ACH-8U), you can't use the phone until it has enough charge to operate.

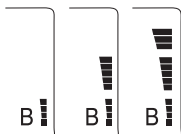

After the segments of the battery indicator bar stop scrolling and the bar is entirely displayed, the battery is charged.

If the battery is too hot or cold, the charging may be interrupted.



Charging Times

The battery charging times below are approximate.

Battery	Standard Charger (ACH-8U)	Rapid Charger (ACH-6U)
Slim 800 mAh NiMH (BMT-1L)	6 hours	90 minutes
Extended 800 mAh NiCd (BKL-2S)	6 hours	90 minutes

Talk and Standby Times

Battery operation times depend greatly on how you use the batteries, as well as on the coverage of the network and network parameters set by the cellular service provider.

Battery	Talk Time	Standby Time
Slim 800 mAh NiMH (BMT-1L)	1 hour 40 minutes	21 hours
Extended 800 mAh NiCd (BKL-2S)	1 hour 40 minutes	21 hours

To Discharge the Battery

A battery lasts longer and performs better if you fully discharge it from time to time!

To discharge the battery, either leave your phone switched on until it turns itself off or use the battery discharge feature of any approved accessory available for your phone.

Note: Do not attempt to discharge the battery by any other means.

Battery Low

You get this message and a warning tone when the battery charge is low and only a few minutes of talk time remain.

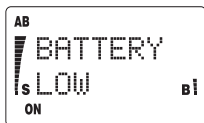

When the battery charge is too low for the phone to operate, RECHARGE BATTERY is displayed and a warning tone is given. After about 10 seconds, the phone automatically switches itself off.

Note: If Silent Service has been selected, no audible warning tones are given.

Charge the battery as described earlier in this section.

Important Battery Information

- Use only batteries and chargers approved by the phone manufacturer.
- When a charger is not in use, disconnect it from the power source. Do not leave the battery connected to a charger for longer than a week; overcharging may shorten its life.
- If left unused, a fully charged battery will discharge itself in about a week at room temperature.
- Never use any charger or battery that is damaged or worn out.
- Use the battery only for its intended purpose.
- Do not short circuit the battery. Accidental short circuiting can occur when a metallic object (e.g. coin, clip, or pen) causes direct connection of the + and - terminals of the battery (metal strips on the back of the battery), for example when you carry a spare battery in your pocket or purse. Short circuiting the terminal may damage the battery or the connecting object.
- Leaving the battery in hot or cold places, such as in a closed car in summer or winter conditions, reduces the capacity and lifetime of the battery. Always try to keep the battery between 59°F and 77°F (15°C and 25°C). A phone with a hot or cold battery may temporarily not work (or charge) even if the battery is fully charged. NiMH battery performance is particularly limited in temperatures below 14°F (-10°C).
- Temperature extremes affect the ability of your battery to charge: it may require cooling or warming first.
- When the battery is not in use, store it uncharged in a cool, dark and dry place.
- The battery is a sealed unit with no serviceable parts. Do not attempt to open the case.
- It is recommended that you allow your battery to fully discharge before you recharge it.

- The battery can be charged and discharged hundreds of times but it will eventually wear out. When the operating time is noticeably shorter than normal, it is time to buy a new battery.
- Do not dispose of a battery in a fire!
- Dispose of used batteries in accordance with any local regulations.



NICKEL CADMIUM BATTERIES MUST BE RECYCLED OR DISPOSED OF PROPERLY. MUST NOT BE DISPOSED OF IN MUNICIPAL WASTE.

Signal Strength Indication

A cellular phone sends and receives radio signals. As with all radio equipment, the quality of radio reception depends on the strength of the radio signal in the area where you are operating your phone.

The strength of the cellular signal is shown by the vertical bar on the left-hand side of the display. The higher the bar, the stronger the signal is where you are operating your phone.



When **NO SVC** is displayed, the phone is outside of the cellular service area and calls cannot be made or received.

If the signal is poor and you are using the phone in a building, you may get better reception near a window.

3. The Basics

Switching On/Off

Press and hold the power key for one second to switch the phone on or off.

IMPORTANT! Do not switch on the phone when cellular phone use is prohibited or when it may cause interference or danger.



Making a Call

If your phone has an extendable antenna, extend the antenna fully. As with any other radio transmitting device, avoid unnecessary contact with the antenna when the phone is switched on.

Enter the area code + number, then press **SEND**.

Check with your operator to see if you must enter the area code.

If the **PIN CALL** is set to on, press **SEND** again after the tone. See "To Activate PIN Call" on page 14 for details.

If you make a mistake dialing, press **CLR** to erase digits one by one. Press and hold **CLR** to clear the whole display.

NO SERVICE appears and a beep is given if you try to make a call when your phone is outside of the cellular service area.

NOT ALLOWED appears if you try to make a restricted call.

PRESS MENU appears if Keyguard is on.

IN USE and the dialed phone number appears on the display when you press **SEND**. The call is connected when the phone number disappears from the display.



To make a call while you have a call in progress:

Enter the phone number or recall the number from the memory and press **SEND**. This puts the current call on hold and dials the new call.

Note: You can do this only if you have subscribed to this network service.

Ending a Call

Press **END**.

Note: If you press and hold **END**, Keyguard is activated. To deactivate Keyguard, press **MENU** then *****.

Answering a Call

Press any key except the power or **END** keys.

Note: You can press **END** to silence the ringing of an incoming call. Pressing **END** will not answer the call.

To answer a waiting call (normally indicated by a beep) press **SEND**.

Note: If Keyguard is active, a call can only be answered with **SEND**.

Note: Call Waiting is a network feature. You need to subscribe to it through your service provider to use it.

Calling Line Identification

If you have subscribed to and activated Calling Line Identification (a network service), the phone displays the caller's phone number as the phone rings.

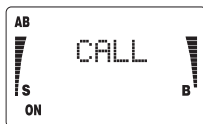

The phone displays the caller's name if you have that person's name and number stored in your phone. Otherwise it displays CALL, NO ID CALL, or PRIVATE ID CALL.

If you have set Ringing Volume to SILENT SERVICE, the phone's lights flash and the phone makes a short beep. You can answer a call any time, even while using the Keyguard, memory or menu functions.

If you don't answer a call, the message 1 CALL MISSED or n CALLS MISSED will remain on the display until you press any key (except the on/off key) to clear the display. The phone stores the caller's number (if available) in the list of Missed Calls (see "Menu 15, Call Register" on page 34).



Adjusting the Earpiece Volume

During a call, press ▼ or ▲ to decrease or increase the earpiece volume level. The display must be clear.

Note: The ▼ and ▲ keys scroll through memory and the menu when not in a call.



Last Number Redial

Clear the display then press  .

Last 10 Dialed Numbers

Clear the display then press . Press ▼ until you see the number you want. Then press  to dial it.

The phone stores the last 10 phone numbers you called or attempted to call. This list remains in the phone's memory when the phone is switched off.

If the stack of the last dialed numbers is empty, the message LOCATION EMPTY will be displayed.

See “Menu 15, Call Register” on page 34.

Speed Dialing

Press a location number (1-40) then .

The phone recalls the number stored in the corresponding location number in your phone directory (see “The Phone Directory” on page 16), displays it briefly, then dials it. If the memory location is empty, the message LOCATION EMPTY is displayed.

1 Touch Dialing

Hold  for a few seconds.

The phone dials the number stored in location 1 of your phone directory (see “The Phone Directory” on page 16). You may want to store your voice mailbox number in location 1 if you have subscribed to voice mail (see below).

To store the number in the phone directory location 1, see “To Store Numbers and Names” on page 17.

Using Your Voice Mailbox

If you have subscribed to voice mail service and notification through your service provider, your phone displays the icon  when you have a voice message in your voice mailbox.

If you have stored your voice mailbox number in location 1, you can simply press and hold **100** to call your voice mailbox. Otherwise, dial your voice mailbox number to listen to your messages.

9 Key Emergency Dialing

Press and hold **9 wxyz** for more than 4 seconds.

The phone dials the emergency number programmed into your phone and displays the message EMERG. CALL TRY if **Emergency Key 9** is set to on (EMERG. 9 ON).

The emergency number is displayed only after you have entered the last digit of the number.

Note: Official emergency numbers vary by location (e.g., 911 or another official emergency number). However, only one emergency number is programmed into your phone to be dialed automatically by one-touch emergency dialing, which may not be the proper number in all circumstances.

*Note: 9 Key Emergency Dialing does not operate when the Keyguard feature is activated. However, an emergency call can be made without deactivating the Keyguard by entering the whole emergency number programmed into your phone and then pressing **SEND**.*

Keyguard

- Press and hold **END** to activate Keyguard.
- Press **MENU** then ***** to deactivate Keyguard. You can also activate Keyguard this way.

Keyguard locks the phone's keypad to prevent accidental keypresses (e.g. when the phone is in a pocket or a bag).

KEYGUARD ACTIVE remains on the display until Keyguard is deactivated.

Answering a call with Keyguard active

Press .

During the call, the keypad remains unlocked and the phone can be used normally. After the call is ended, Keyguard automatically becomes active again.

The phone cannot be switched off when Keyguard is active. However, if you give a quick press to the power key with Keyguard active, the phone's lights go on for 15 seconds, regardless of the Lights setting.

Note: When Keyguard is activated, calls may be possible to the emergency number programmed into your phone (e.g., 911 or another official emergency number). However, one-touch 9-key emergency dialing (the 9 key) does not operate.

To make an emergency call with Keyguard active

Enter the emergency number preprogrammed into your phone (e.g. 911) and press .

The emergency number is displayed only after you have entered the last digit of the number.

The phone dials the emergency number programmed into the phone and displays the message EMERG. CALL TRY.

Calling Card Call

When making a call, the call charges can be directed to a selected long distance service provider, if the card number is sent to the network during the call setup.

Before making an automatic calling card call, you have to activate one of the calling card options from the menu

CALLING CARD.

- 1)** Enter the area code and phone number.
- 2)** Press and hold  for more than one second.

Note: If no calling card is activated, the phone will make a normal call to the phone number entered.

CARD CALL remains on the display until the access number has been sent to the network. The phone asks you to WAIT FOR PROMPT.

- 3)** After the tone or voice prompt, press **SEND**.

CARD CALL remains on the display; the phone asks you to again WAIT FOR PROMPT.

- 4)** If you get another tone or voice prompt, press **SEND** again.

Note: This procedure may not apply to all calling card options programmed into your phone. Please look at the back of your calling card or contact your long distance company for more information.

If you are making a calling card call with PIN CALL ON, go through steps 1 and 2 above. The phone displays PIN CALL. When you hear a tone, press **SEND**. Then continue with steps 3 and 4 above.

PIN Call

You can activate or deactivate **PIN Call**, a security feature that requires a PIN Code every time you make a call.

Note: If you are using the phone in an area that doesn't require PIN dialing, deactivate PIN Call.

To Activate PIN Call

- 1)** Enter *** # 7 4 6 2 2 5 5 #** (spells PINCALL).

- 2)** The phone asks for your four-digit PIN Code. Enter your PIN code and press **OK**.

The phone briefly displays PIN CALL ON.

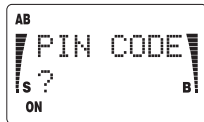

Making a Call with PIN Call On

- 1)** Make the call as usual (see "Making a Call" on page 8).

The phone displays PIN CALL.

- 2)** After you hear a tone, press **SEND** again.

Wait for your call to be connected.

*Note: If you're in a network that doesn't support PIN Calls, but your phone has PIN Call On, the phone tries to send a PIN anyway. To stop this, make the call as usual, then press **CLR** to end the PIN Call attempt.*

To Deactivate PIN Call

- 1)** Enter *** # 7 4 6 2 2 5 5 #**.

The phone asks for your four-digit PIN Code.

- 2)** Don't enter your PIN Code, just press **OK**.

The phone briefly displays PIN CALL OFF.

Note: When the phone is set to PIN CALL ON, an emergency call to the emergency number programmed into your phone (e.g., 911 or another official emergency number) will be dialed as a normal call without the PIN code request.

What is Prepaid Mode?

To activate your phone through TRACFONE[®], call the toll free number on the card included with this Owner's Manual.

If you activate your phone through TRACFONE, see "Menu 16, Debit" on page 35 for information on the features available.

Important note: Your phone cannot be activated through TRACFONE and another cellular service provider at the same time.

Note: If you have questions regarding any of the prepaid features in your phone, contact TRACFONE Customer Service at 1-800-867-7183.

4. The Phone Directory

Your phone can store:

- up to 40 names and numbers in its directory
- one additional number in a “notepad”, which is erased whenever you switch off the phone

Stored names can be up to 16 characters long and numbers can have up to 32 digits.

See “Memory Location 40” on page 20 for an important note about Memory Location 40.

Alpha Mode

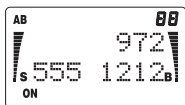

To enter names, retrieve numbers based on names, and view names, press . The phone displays **ABC** to indicate that you can use keys to enter letters, and that you are viewing names rather than numbers.



When a name is displayed you can also press  to see the associated number.

To Enter Letters

Put the phone in Alpha mode by pressing . You can then enter letters. The table on the next page shows the characters you can enter while the phone is in Alpha mode.



To correct mistakes, press  or press and hold  to clear the whole display.

Key	One press	Two presses	Three presses	Four presses
1	-	&	.	:
2	A	B	C	
3	D	E	F	
4	G	H	I	
5	J	K	L	
6	M	N	O	
7	P	Q	R	S
8	T	U	V	
9	W	X	Y	Z
*	Enter another letter from the same key without waiting for the cursor to move to the next space.			
#	Space between letters			

The identical name may be used only once in memory. REPLACE NAME? appears when you try to store a name already in memory.

To Store Numbers and Names

Quick Store

- 1) Clear the display, then enter the area code and phone number.
- 2) (Optional:) Press  then enter the name.
- 3) Press and hold .

The phone stores the number in the first empty memory location. If there aren't any empty spaces you get the message NO SPACE.

Menu Method

- 1) Press **MENU** ▼ **OK** .
The phone prompts you for a name:

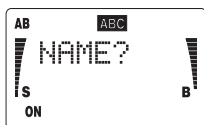

- 2) Enter a name then press **OK** . If you don't want to store a name, just press **OK** at the prompt.

The phone prompts you for a number:

- 3) Enter the area code and phone number then **OK** .

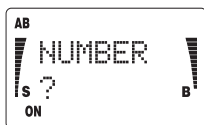

The phone prompts you to store the number in the first available memory location:

- 4) Press **OK** or enter the location number where you want the number to be stored then press **OK** .

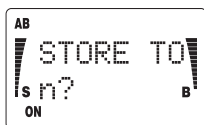

*Note: To store the number in the "notepad", press **#** at the "STORE TO n?" prompt then press **OK***

Storing Pause and Wait Characters

You can store a 2.5 second pause (p) or a wait (w) character in a stored number. The reason to do this is for automatic sending of Touch Tones.

- 1) To enter a Pause ("p"), press **MENU** **#** .

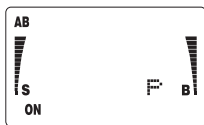

- 2) To enter a Wait ("w"), press **MENU** **#** **#** .



For more information on the use of “pause” and “wait” characters, see “Automatically Sending Touch Tones” on page 40.

Notes about Storing Numbers

REPLACE NAME?

This appears if the name is already in use. The phone displays the number (in the upper right hand corner) of the location where it is stored. To replace the information already stored, press **OK**.

STORE TO?

This appears if there is no empty location available. Enter the memory location where you want to store the information (existing content will be overwritten). Enter a location number and press **OK**.

REPLACE CONTENT?

This prompts you to replace the contents of the selected location. To replace the information, press **OK**.

ALREADY STORED

This appears if both the phone number and name are already stored. The phone prompts you to move the information to the first empty memory location (e.g., MOVE TO 5?). Press **OK**, or enter a different location number then press **OK**.

Press **CLR** if STORE, REPLACE or MOVE appears and you do not want to continue.

The phone exits the store function, and the information you tried to store reappears on the display. You can re-attempt to store the information in the phone directory memory as described above, or you can clear the display by pressing and holding **CLR**.

To Change the Number Stored with a Name

- 1) Recall the number from memory.
- 2) Use the **CLR** key to erase the current number one digit at a time, then key in the new number.

- 3) Press and hold **OK**.
The phone gives you the prompt shown.

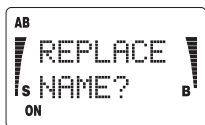

- 4) Press **OK** at the
REPLACE NAME? prompt.

See “To Recall Stored Numbers” on page 21 for more information.

Memory Location 40

Memory Location 40 is special. If you store a number in Memory Location 40 (you would do this in Step 4 of “Menu Method” on page 18), you can make calls to that number even if you turn on the **INCOMING ONLY** restriction under Menu 4, Restrict Calls. See “Menu 4, Restrict Calls” on page 24.

To Erase Stored Names and Numbers

To Erase by Name

- 1) Press **MENU** ▼▼▼
OK. The phone
prompts you for a name:

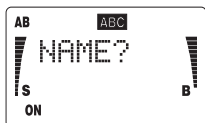

- 2) Press ▼ until you see the
name you want to erase.
At the **ERASE?** prompt,
either press **OK** to erase or press **CLR** if you
change your mind and don't want to erase and you
want to quit.

The phone displays **ERASED** or **NOT ERASED**.

To Erase by Number

- 1) Press **MENU** ▼▼▼ **OK**. The phone prompts
you for a name, as in Step 1 above.

2) Press **ABC** and the phone asks, LOCATION?.

3) Press **▼** until you see the number you want to erase, or enter a location number. At the ERASE?

prompt, press **OK** or press **CLR** if you change your mind.

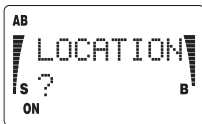

The phone displays ERASED or NOT ERASED.

Note: The notepad memory is automatically erased when you switch the phone off.

To Recall Stored Numbers

With the display clear of numbers, press and hold **▼** to scroll through stored numbers.

To Recall Stored Names

With the display clear of numbers or names, press **ABC** then **▼**. Or, press **ABC** then enter the first few letters of the name and press **▼**.

The phone scrolls through stored names.

You can also use Menu 2, Find Name:

1) Press **MENU** **▼▼** **OK**. The phone prompts you for a name:

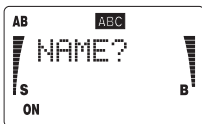

2) Key in the name or its first letter(s), or press **▼** until you see the name you want. If you don't enter anything for 5 seconds after NAME? displays, the first stored name will appear. Press **ABC** to display the phone number.

3) Press **SEND** to make a call to the displayed name or phone number.

5. The Menu

When you press **MENU**, you get this screen. Press ▼ or ▲ to scroll through the menus. Each menu allows you to see and change specific phone settings.



When you're scrolling through the menus, press **OK** when you see the menu you want.

Use the ▼ or ▲ key to scroll through the setting options of a menu. The current setting is always displayed first. Press **OK** to set the option to the item shown on the screen.

Use **CLR** to exit the menu without changing the settings.

Accessing Menus by Number

The menu functions are numbered. You can get into menus 1 to 9 by pressing **MENU** then the menu number.

Note: Menus 10 to 16 cannot be accessed by using this method.

Once you're in the menu, use the ▼ or ▲ key to scroll through the available settings. The current setting is always displayed first.

Press **OK** to select the displayed setting, or use **CLR** to exit the menus without changing the settings.

List of Menu Functions

1 Store to Memory

Stores information in memory

2 Find Name

Recalls memory entries

3 Erase Name

Erases memory entries

4 Restrict Calls

Sets call restriction level:

Allow All

Incoming Only

Memory Only

5 System Select

Sets the roaming option:

Home Type A or B

Non-Home Type A or B

Home Area

Any

PREFER'D (optional)

6 Call Timers

Shows and resets call timers:

Last

Total 1

Total 2

Life

Clear Timers

7 Lights

Sets display lights on/off

8 Keypad Tones

Sets keypad tones on/off

9 Ringing Volume

Sets ringing tone volume (3 volume levels)

10 Ringing Type

Selects ringing types (5 types)

11 Emergency Key 9

Sets the 9 Key Emerg. dialing on/off

12 NAM Select

Shows and selects your cellular number

13 Calling Card

Selects and activates a calling card option

14 Change Lockcode

Changes the four-digit lock code

15 Call Register

Shows temporary lists:

Missed Calls

Clear Lists

Received Calls

Dialed Calls

16 Debit

TIMETANK INFO

CHECKSUM

Keyguard - **MENU** *

Activates/deactivates Keyguard

Pause - **MENU** #

Wait - **MENU** ##

Adds a Pause or Wait character to a stored number

Some menu functions described below can be operated in several different ways. Only one alternative is described here, with references to alternative methods.

Menu 1, Store To Memory

You can store names and phone numbers in the phone with this menu. See “Menu Method” on page 18 for details on storing names and numbers with Menu 1.

Menu 2, Find Name

You can find phone numbers and names stored in the phone with this menu. See “To Recall Stored Names” on page 21 for details on finding a name with Menu 2.

Menu 3, Erase Name

You can erase the contents of a memory location by name or memory location number with this menu.

See “To Erase Stored Names and Numbers” on page 20 for details on erasing memory location contents with Menu 3.

Menu 4, Restrict Calls

You can restrict certain types of calls with this menu. You need your four-digit lock code to change any of the settings in this menu.

ALLOW ALL means that there are no restrictions to incoming or outgoing calls.

INCOMING ONLY means that you cannot make outgoing calls; you may only receive calls. However, you can make calls to the number stored in location 40 and to the emergency number preprogrammed into your phone. See “Memory Location 40” on page 20.

MEMORY ONLY means that you can make outgoing calls only to numbers stored in the phone’s memory. You

can also make calls to the emergency number preprogrammed into your phone.

Note: You can't store any numbers in the phone directory when this setting is INCOMING ONLY or MEMORY ONLY.

To Set the Call Restriction

1) Press **MENU** ▼▼▼▼

OK (Or press **MENU**)

4). The phone shows the current call restriction setting.

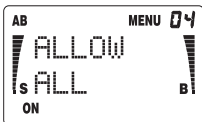

2) Press ▼ until you see the option you want (ALLOW ALL, INCOMING ONLY, or MEMORY ONLY) then press **OK**.

3) The phone prompts you to enter the lockcode. Enter it then press

OK.

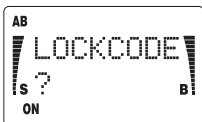

Note: You can't change any of the settings if you don't know the lockcode!

If you enter the wrong lockcode, the phone displays CODE ERROR and exits the menu.

Note: When calls are restricted, calls may be possible to the emergency number programmed into your phone (e.g., 911 or another official emergency number) including calls by one-touch emergency dialing.

Menu 5, System Select

Your "home" network (that is, the network through which you have cellular service) is either of type "A" or "B". Many areas that provide cellular service have both an A and B system. The phone shows the selected system type (A or B) in the upper left corner of the display.



With Menu 5, you tell the phone which system to choose when you roam (that is, try to use your phone in an area other than your “home” network). Your phone must choose which system to use (A or B) so it takes the information from your choice in Menu 5.

Contact your cellular service provider for information about the roaming agreements they have with other cellular service providers.

To Select the Roaming Mode

- 1) Press **MENU** ▼▼▼▼▼
OK (Or press **MENU**
5). The phone shows the current System Select setting.



- 2) Press ▼ until you see the option you want (ANY, HOME TYPE A or B, NON-HOME TYPE A or B, HOME AREA, or PREFER'D) then press **OK**.

ANY means that the phone uses both systems A and B. The phone uses its home system when possible and the non-home type system when service is not available in its home type system.

HOME TYPE A (or HOME TYPE B) means that the phone uses only its home type system (A or B). Note that the phone displays HOME TYPE A or HOME TYPE B depending on whether your phone's home system is type A or B.

NON-HOME TYPE A (or NON-HOME TYPE B) means the phone uses only the non-home type system (A or B, depending on what your phone's home system type is).

HOME AREA means the phone uses only its home area and home system. In other words, it cannot roam.

PREFER'D allows you to use information programmed into your phone by your service provider. This information lists the networks in which the phone will provide the best possible service.

- Press **OK** to select the PREFER'D option.

Depending on the programmed information, and the actual network availability in the area where you are using the phone, selecting the PREFER'D option has the effects described below.

Note: The PREFER'D option appears only if your service provider has programmed a list of preferred networks into your phone.

If you select PREFER'D, your phone may be able to select the preferred (e.g., low-cost billing rate) type of network. If service is available only within a non-preferred type of network, the **NO** part of **NO SVC** will flash and only emergency calls to the emergency number programmed into your phone may be possible.

Note: When you select PREFER'D, and you're within a non-preferred network, only calls to the emergency number programmed into your phone (e.g., 911 or another official emergency number) may be possible.

How to Roam

In some areas, the cellular system automatically recognizes roaming phones. In other areas, you need to contact the service provider before the system can recognize your phone. The operator needs to know your phone number, your phone's ESN (electronic serial number), and how you plan to pay for your calls. There is normally an additional charge for roaming calls.

Note: The ESN of your phone is located under the battery of the phone. (However, the ESN of your phone can normally be read over the air by the roaming cellular service providers when you call them to register your roaming presence on their cellular network.)

Menu 6, Call Timers

This menu lets you see approximately how much time you've spent in calls on your phone. You can also reset the timers to zero (except for the Life Timer).

- 2) Press ▼ to LIGHTS ON or LIGHTS OFF then press **OK**.

With Lights On

If the phone is in hand-portable mode or connected to a charger, the lights come on when you press a key, and stay on for 15 seconds. The lights also come on when the phone rings and stay on for 15 seconds after the phone rings.

When the phone is connected to a handsfree car kit, the lights remain on continuously.

With Lights Off

If the phone is in hand-portable mode or connected to a charger, the lights remain off continuously.

When the phone is connected to a handsfree car kit, the lights come on when you press any key and stay on for 15 seconds. The lights also come on when the phone rings and stay on for 15 seconds after the phone rings.

Menu 8, Keypad Tones

When you press the buttons on your phone, the phone beeps (the sound depends on which key you press). With this menu, you can turn the beeping sounds on or off.

- 1) Press **MENU** 8. The phone shows the current setting.
- 2) Press ▼ to KEYTONES ON or KEYTONES OFF then press **OK**.



Note: You can still send DTMF tones even when the keypad tones are switched off.

Note: Keypad tones are set off when you choose SILENT SERVICE in Menu 9, Ringing Volume.

Menu 9, Ringing Volume

With this menu you choose the ringing volume. As you scroll through the options RINGING HIGH and RINGING LOW, the phone rings so you can hear what each setting sounds like.

1) Press **MENU** 9. The phone shows the current setting.



2) Press **▼** to RINGING HIGH, RINGING LOW, or SILENT SERVICE then press **OK**.

If you choose SILENT SERVICE, the phone won't ring when you have an incoming call. Instead it beeps once, flashes the lights, and displays CALL. The phone displays SILENT when you aren't in a call and when you aren't using the other functions of the phone. This message is to remind you that the ringing tone is set to off.

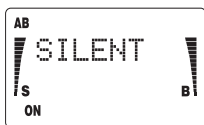

Note: All other tones of the phone, except for the charger connected tone, are also switched off.

Menu 10, Ringing Type

With this menu you choose the ringing type. As you scroll through each of the five options, the phone rings so you can hear what each type sounds like.

1) Press **MENU** then press **▼** until you get to RINGING TYPE then press **OK**. The phone shows the current setting.



2) Press **▼** to hear the types, then press **OK** when you hear the one you want.

Menu 11, Emergency Key 9

This menu lets you set the 9 key one-touch emergency dialing on or off. The default setting for the feature is EMERG. 9 ON.

With EMERG. 9 ON, your phone dials the emergency number programmed into your phone when you press and hold **9** wxyz. See “9 Key Emergency Dialing” on page 12.

To set the Emergency Key 9 on or off

- 1) Press **MENU** and press ▼ until you get to EMERG. KEY 9 then press **OK**. The phone shows the current setting.



- 2) Press ▼ to EMERG. 9 OFF or EMERG. 9 ON, then press **OK**.

Note: The Emergency Key 9 one-touch dialing operates when calls are restricted, but does not operate when the Keyguard is on.

Menu 12, NAM Select

Your phone can have two different telephone numbers. Each number is stored in a NAM (Number Assignment Module). This menu lets you choose which telephone number (NAM) to use. Note that in order to have two different telephone numbers, you must subscribe to them through your cellular operator(s).

- 1) Press **MENU** then press ▼ until you get to NAM SELECT then press **OK**. The phone shows the current NAM (phone number).

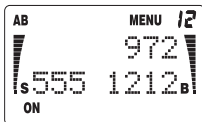

- 2) Press ▼ to the NAM you want (if there are two available) then press **OK**.

Note: If only one NAM is programmed into your phone, only that number can be selected from this menu.

Note: The phone cannot use both numbers at the same time and you cannot change the number during a call.

Note: If your phone is set to your first number, you can only receive calls via that number. You may be able to forward calls from your second number to your first number so you don't miss any calls, if this service is available from your network provider. For more information, please contact your cellular service provider.

Menu 13, Calling Card

This menu lets you store calling card information in your phone. You can select the calling card option, or you can select NO CARD. For making an automatic calling card call, see "Calling Card Call" on page 13.

You need to store the calling card information in your phone to use this feature. After you store the information, that option is also the one used when you make Calling Card calls.

- 1) Press **MENU** then press ▼ until you get to CALLING CARD then press **OK**. The phone asks you for your lockcode.

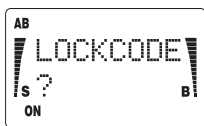

- 2) Enter the lockcode and press **OK**. The phone displays the currently-selected option or NO CARD.

- 3)** Select whether your calling card is Card Type A, B, C, D, or E (described below).

Card Type	Includes these cards	Uses this U.S.A. access number
A	Sprint MCI PacBell	1-800-877-8000 1-800-950-1022 1-800-555-5321
B	MCI MCI GTE	1-800-888-8000 1-800-674-0700 1-800-225-5483
C	AT&T Sprint PacBell	1-800-225-5288 1-800-277-7468 1-800-522-2020
D	AT&T10 Sprint Ameritech	10288 10333 (press OK at ACCESS NUMBER? prompt)
E	MCI	1-800-999-9000

Press ▼ to the option you want then press **OK**.
If you select NO CARD, previously stored calling card data is erased and the phone exits the menu facility.

- 4)** At ACCESS NUMBER?, enter the telephone number to access your calling card provider then press **OK**.

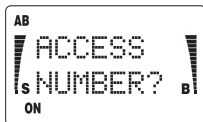

At CARD ID CODE? enter your card number (including any PIN number) then press **OK**.

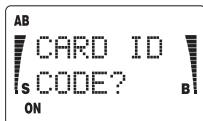

When STORED is briefly displayed, the card has been activated, and the previously stored calling card data erased.

Note: To exit the menu without changing the calling card settings, press and hold **CLR** at the CARD ID CODE? prompt.

Menu 14, Change Lockcode

This lets you change your phone's four-digit lockcode.

- 1) Press **MENU** then press ▼ until you get to CHANGE LOCKCODE then press **OK**. The phone asks you for your lockcode.

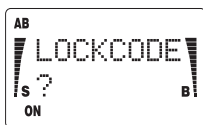

- 2) Enter the lockcode and press **OK**.

If you enter an incorrect lockcode, the phone displays CODE ERROR and exits the menu.

- 3) The phone asks for a new lockcode. Enter a new code (four numbers) and press **OK**.

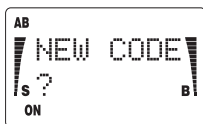

- 4) When the phone prompts you to CONFIRM the new lock code, reenter the numbers you entered in Step 3 then press **OK**.

STORED confirms that the lock code has been changed.

Menu 15, Call Register

To access this menu, press **MENU**, then press ▼ or ▲ to scroll to CALL REGISTER, then press **OK**. Next, press ▼ or ▲ to scroll through the lists of calls that the phone keeps for you. Press **OK**, to select one of the lists:

MISSED CALLS shows you the phone number(s) of the last 10 people that have tried to call you, but you haven't answered the phone.

Note: This feature might not be supported in your network. Contact your service provider for details.

If there are 10 missed calls saved in your phone, the next missed call is added to the list and the oldest missed call in your phone is dropped.

If you don't answer a call, the message 1 CALL MISSED or n CALLS MISSED will remain on the display until you press any key (except the on/off key) to clear the display.

- 1) When your phone alerts you that you have missed calls, you can view the numbers by scrolling to the CALL REGISTER menu, or by simply pressing ▼ or ▲. The missed calls are stored in your phone in the order they were received.
- 2) To dial a number in the Missed Calls list, scroll to the number you wish to call and press **SEND**. Once you dial a number from the Missed Calls list, the number is dropped from this list and added to the Dialed Calls list.

CLEAR LISTS erases the Missed Calls, Received Calls, and Dialed Calls lists. You need to enter the phone's lock code to clear lists.

RECEIVED CALLS shows you the phone number(s) of the last 10 people who have called and reached you.

DIALED CALLS shows you the last 10 phone numbers you've dialed.

Note: The phone displays the phone number of received and missed calls only if the cellular system is able to identify the caller and you have Calling Line Identification active. See "Calling Line Identification" on page 9.

Menu 16, Debit

If you activate your phone as prepaid through TRACFONE, your phone will have an additional menu item called DEBIT.

If you activate the prepaid option, your phone functions the same way as it did before, with some additional features. These features are listed and explained in this section.

To access the Debit menu, press **MENU** then press ▲ to go immediately to the Debit menu. Press ▼ or ▲ to scroll through the menu options.

TIMETANK INFO shows you the amount of prepaid airtime units you have left in your phone.

At the **TIMETANK INFO** screen, press **OK**, and your phone displays the number of units remaining (indicated as U) as well as the date by which you should redeem another prepaid cellular card.

CHECKSUM is a customer service only menu item, used for debit verification.

Adding Airtime Units to Your Phone

Each time you want to add units to your phone, you must purchase another TRACFONE prepaid cellular card and then contact TRACFONE customer service.

Important note: You must add airtime units to your phone every 60 days (before your airtime card due date) to maintain your cellular service or your service will be interrupted. To reactivate service, redeem a prepaid cellular card and a new number will be issued to you.

Switching On/Off

When you first turn your phone on, **REMEMBER AIRTIME CARD DUE** and a date appear.

This reminds you that this is the date you must purchase additional airtime in order to retain your current phone number and cellular service. The date automatically updates once you add units to your phone.

UNITS and the number of units currently in your phone appears after another few second pause. This number automatically updates while you are in a call, at the end of a call, and once you add units to your phone.

*Note: When your phone displays the **REMEMBER AIRTIME** message, you can press any key to skip the subsequent **CARD DUE** and **UNITS** messages and ready the phone for immediate use.*

Making a Call

For complete information on making a call, refer to “Making a Call” on page 8.

Once you have placed a call your phone displays the charge rate of units per minute as well as a timer which tracks the duration of the call expressed in minutes and seconds.

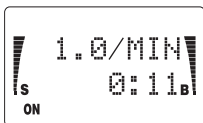

When there are only ten minutes of talk time left in your phone, your phone sounds a beep that continues once a minute. If you hang up before the amount of time in your phone expires, your phone continues to beep once a minute during the next call.

If you try to make a call and there are no units left in your phone, your phone beeps and displays the message **TIMETANK EMPTY.**

Ending a Call

For complete information on ending a call, refer to “Ending a Call” on page 9.

Once you press **END**, your phone displays the remaining units (indicated as U) and the duration of the call expressed in minutes and seconds.

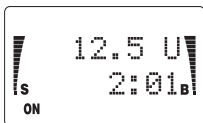

Note: Due to rounding, there may be a difference between the call time length shown on the screen after you terminate a call and the call time length shown under the menu, Call Timers.

Answering a Call

For complete information on answering a call, refer to “Answering a Call” on page 9.

Note: Call Waiting is not available if your phone is in prepaid mode.

When you answer a call your phone displays the charge rate of units per minute as well as a timer which tracks the duration of the call expressed in minutes and seconds.

After three seconds the charge rate of units per minute is replaced by only the number of units remaining in your phone (indicated as U).

When there are only ten minutes of talk time left in your phone, your phone sounds a beep that continues once a minute. If you hang up before the amount of time in your phone expires, your phone continues to beep once a minute during the next call.

If there are no units left in your phone, your phone will not ring for incoming calls.

9 Key Emergency Dialing

For complete information on 9 key emergency dialing, refer to “9 Key Emergency Dialing” on page 12.

When you make an emergency call, the amount of units being used and the duration of the call are not tracked by your phone.

This means you are not charged for 911 calls. Even when there are no units in your phone, you are able to make 911 calls.

Making a Calling Card Call

For complete information on making a calling card call, refer to “Calling Card Call” on page 13.

While you are in a call, your phone displays the number of units being used, as well as a timer which tracks the duration of the call.

Making a Call with PIN Call On

For complete information on making a call with PIN call on, refer to “Making a Call with PIN Call On” on page 14.

Once the call is connected, your phone displays the number of units being used, as well as a timer which tracks the duration of the call.

NAM Select

If your phone is in prepaid mode, you cannot change the NAM programming. For complete information on NAM selection, refer to “Menu 12, NAM Select” on page 31.

6. Additional Features

Sending DTMF (“Touch”) Tones

Your phone is a “Touch Tone” phone. Touch Tones are the sounds your phone makes when you press the keys. Touch Tones can be used for many automated phone services such as checking your bank balance and using voice mailbox options.

Touch Tones are called “DTMF” (Dual Tone Multi Frequency) tones in the phone.

Manually Sending Touch Tones

Pressing the keys during call sends Touch Tones.

- 1)** Make a call in the usual way (e.g. to your bank's computer phone number).
- 2)** Manually enter the digits to be sent as DTMF tones (e.g., your bank account number and password).

Automatically Sending Touch Tones

To automatically send Touch Tones, store the DTMF sequence after the access phone number (separated by a “wait” character). Store “waits” or “pauses” between DTMF digits to be sent (a “pause” cannot be stored as the first special character).

For details on storing “pause” and “wait” characters, see “Storing Pause and Wait Characters” on page 18.

Here is an example of a number you could store in your phone. This number contains a phone number (18005551212), a wait character, an access number (“1234”), a wait character, and a password (“3434”).

18005551212w1234w3434

When you recall this number from memory and press , the phone:

- 1)** Dials 18005551212 (the stored number), then

- 2)** “Waits” for you to press **SEND** again. When you do, the phone sends the numbers 1234.
- 3)** “Waits” for you to press **SEND** again then sends the numbers 3434.

Here is an example that uses both “waits” and “pauses”:

18005551212w1234p3434

When you recall this number from memory and press **SEND**, the phone:

- 1)** Dials 18005551212 (the stored number), then
- 2)** “Waits” for you to press **SEND** again. When you do, the phone sends the numbers 1234.
- 3)** Pauses 2.5 seconds then sends the numbers 3434.

If the Menu 8, Keypad Tones, has been set to off, the DTMF tones will still be sent, but you will not hear them.

To end the call, press **END** after the DTMF transmission is completed and the phone has returned to the normal call mode.

7. Accessories

An extensive range of accessories is available for your phone. You can select the accessories that best accommodate your specific communication needs.

For availability of the accessories, please check with your local dealer.

A few practical rules for accessory operation:

- Keep the accessories out of small children's reach.
- When you disconnect the power cord of any accessory, grasp and pull the plug, not the cord.
- Check regularly that all cellular phone equipment in a vehicle is mounted and operating properly.
- Installation of complex car equipment must be completed by qualified personnel only.

IMPORTANT! Use only batteries, chargers and accessories approved by the phone manufacturer. The use of any other types may invalidate any approval or warranty applying to the phone, and may be dangerous.



ACH-8U Standard Travel Charger

Use this durable and economical charger to charge all battery options. Simply plug the charger into a wall outlet and connect the connector to the bottom of your phone. Check the charging status on the phone display.

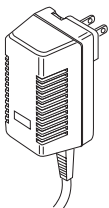

The charging time is approximately 6 hours for both battery options.

Calls can be made during charging, but the charging will be reduced for the duration of the call. Note that if the battery is completely empty, you can't use the phone until it has enough charge to operate.

The Standard Travel Charger is available for different voltage levels and comes with different wall plugs.

ACH-6U Rapid Travel Charger

Extremely light and functionally designed, the Rapid Travel Charger charges your phone battery quickly.

Plug the charger into a wall outlet and connect the connector to the bottom of your phone. When not using the charger, you can wrap the cord around it and attach the loose end to the slot on top.



The charging time is approximately 90 minutes for both battery options. Check the charging status on the phone display. You can use your phone while charging.

Operating within a voltage range of 100V-240V AC (50Hz-60Hz), the Rapid Travel Charger is practically voltage independent in normal office and household use. Like the Standard Travel Charger, the Rapid Travel Charger is compatible with all battery options and is available with different wall plugs.

The Rapid Travel Charger can also be used with the Compact Desktop Charging Stand CGH-9.

CGH-9 Compact Desktop Charging Stand

The Compact Desktop Charging Stand provides mounting for both the phone and a spare battery. Connect your charger to the back of the Compact Desktop Charging Stand, and then plug the charger into a wall outlet. Place your phone and/or a spare battery in the stand to begin battery charging.

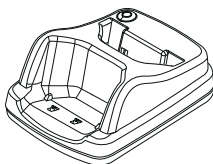

Charging order is the phone battery first, and then the spare battery. Check the charging status of the phone battery on the phone display.

Compatible with all battery options, the Compact Desktop Charging Stand can be used together with the Rapid Travel Charger ACH-6U. The charging time is approximately 90 minutes for both battery options.

In addition, the Compact Desktop Charging Stand offers a discharging facility for the spare battery. Discharging helps extend battery life. Place the spare battery in the stand and press the discharge button. When the battery is totally discharged, recharging will begin automatically. You can also stop discharging before it is finished by pressing the button again. Recharging will begin immediately.

The discharge button is equipped with an LED indicator for the spare battery. A blinking red light indicates discharging. A continuous red light indicates charging, and a green light indicates the spare battery is fully charged. Charge the battery until the light turns green.

DTK-12 Compact Desktop Charger Kit

This kit provides all you need to make the use of your phone as convenient as possible in both home and office environments. It provides you with rapid charging and discharging facilities as well as a place to keep your phone in a convenient ready-to-use upright position.

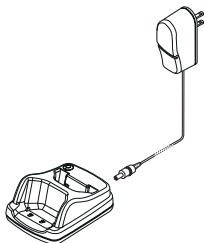

The Compact Desktop Charging Stand CGH-9 and the Rapid Travel Charger ACH-6U are combined to create this kit.

The charging time is approximately 90 minutes for both battery options.

Carry Accessories

A range of carry accessories is available for your phone, including the following:

- Leather Carry Sleeve LCS-4
- Belt Clip BCP-7

HDXK-7 Headset Kit

The compact and functional Headset Kit (Headset Adapter HDA-3 and Headset HDC-2) provides you with a convenient handsfree facility that you can use anywhere.

Connect the Headset Adapter HDA-3 to the bottom of your phone, and plug the Headset HDC-2 to the adapter.

Note: When using the Headset Adapter, connect your charger to the adapter if you need to charge your phone.

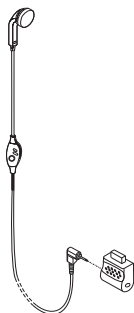

EXK-2 Executive Kit

Consisting of the Rapid Cigarette Lighter Charger LCH-6, Extended 800 mAh NiCd battery BKL-2S and the Leather Carry Sleeve LCS-4, this kit combines extended talk time and mobility.

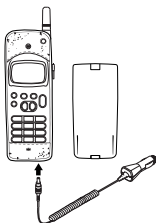

LCH-6 Rapid Cigarette Lighter Charger

The multivoltage Rapid Cigarette Lighter Charger ensures that your phone is always ready for use. The small charger's functional design fits well with most car lighters and interiors.

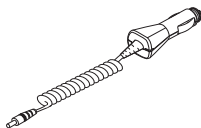

Charging times are the same as those for ACH-6U. The charging time is approximately 90 minutes for both battery options. Calls can be made during the charging. A green light indicates that the Rapid Cigarette Lighter Charger is ready to charge. Check the charging status on the phone display. The input voltage is 12 or 24 V DC, negative grounding.

The Rapid Cigarette Lighter Charger can be used with all accessories available for your phone.

Avoid prolonged charging with the Rapid Cigarette Lighter Charger when the car engine is not running. This may cause the battery of your car to drain.

Note: In some cars the cigarette lighter plug is not provided with power when the ignition is switched off. Verify that the green LED light is on.

LCM-1 Mobile Installation Charger

The multivoltage Mobile Installation Charger powers your phone from the car battery when the ignition is switched on and leaves the cigarette lighter vacant.

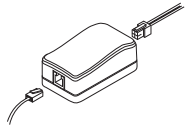

You can use the Mobile Installation Charger in any vehicle with a 12 or 24 V DC connection, negative grounding.

The charging time is approximately 90 minutes for both battery options.

The Mobile Installation Charger housing has a four pin connector for the Power Cable PCM-5, and on the opposite end a connector for the output cable, which connects the Mobile Installation Charger directly to the DC connector of your phone or to the Compact Handsfree Unit.

The Mobile Installation Charger can be installed in the most convenient location for you.

Installation must be made by qualified personnel only.

MBT-9 Mobile Holder

Designed to fit and complement your car's interior, the Mobile Holder holds your phone firmly in place by its three-point hold and sturdy structure.

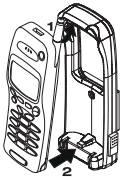

You can easily place the phone into the holder with one hand. Tilt the phone and place it into the holder top first, then push the bottom in until you hear a click.

Pressing the release buttons on both sides of the holder loosens the bottom lock. You can now pick up the phone from the holder and take it with you.

The Mobile Holder is easy to install using a snap-on swivel mount HHS-6 or mounting plate MKE-7 to a convenient location within your car.

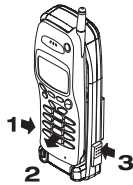

Always secure the phone in its holder. Do not place the phone on the passenger seat or in a place where it can break loose in a collision or sudden stop.

AAE-1 Antenna Coupler

The optional Antenna Coupler AAE-1 provides your phone with access to an external antenna while the phone is mounted in its holder. To enjoy optimum reception quality, fasten the coupler onto the top of the Mobile Holder MBT-9.

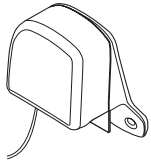

Please note that you will need one of the following combinations to truly benefit from the improved reception:

- Compact Handsfree Unit PHF-5 and HF Microphone HFM-7
- Compact Handsfree Unit PHF-5 and Audio Handset HSU-2

HSU-2 Audio Handset

A simple handset with no display or keypad, the Audio Handset provides privacy for conversation.

Connect the Audio Handset to the bottom of Compact Handsfree Unit PHF-5. The connector is marked with .

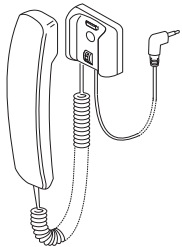

When you lift the Audio Handset from its holder, the HF-loudspeaker and HF-microphone will be muted and you can speak in privacy. When you replace the handset in its cradle, the call is terminated. However, you can press the **MENU** selection key of your phone a few seconds before you replace the handset to retain the call and return to handsfree mode.

CARK-80 Mini Car Kit

The Mini Car Kit provides you with a quick charging facility and holds your phone firmly in place. It is comprised of the Mobile Holder MBT-9 and the Rapid Cigarette Lighter Charger LCH-6, snap on swivel mount HHS-6 and mounting plate MKE-7. See previous sections for more information on these kit components.

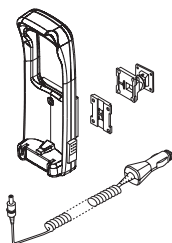

CARK-82 Compact Handsfree Car Kit

You may choose the Compact Handsfree Car Kit to provide a convenient charging facility combined with external antenna connection and handsfree capability as well.

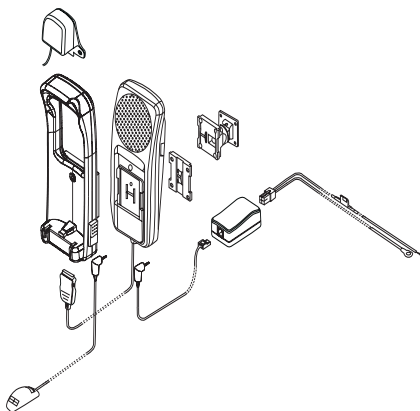

- The Mobile Holder MBT-9 keeps your phone firmly in place.
- The Compact Handsfree Unit PHF-5 with its internal speaker and HF Microphone HFM-7 offers you a seamless handsfree function.
- The Antenna Coupler AAE-1 can be attached directly to the Mobile Holder MBT-9 to provide connection to an external antenna for optimum reception quality.
- The Mobile Installation Charger LCM-1 can be connected to the Compact Handsfree Unit PHF-5 to power your phone from the car battery via the ignition.
- *May be used with the optional Audio Handset HSU-2, for private conversations.*

Note that complex car accessories must be installed by qualified personnel only.

8. Reference Information

Important Safety Information

Traffic Safety

Do not use a hand-held phone while driving a vehicle. If using a hand-held phone, park the vehicle before conversing.

Always secure the phone in its holder; do not place the phone on the passenger seat or where it can break loose in a collision or sudden stop.

The use of an alert device to operate a vehicle's lights or horn on public roads is not permitted.

Remember, road safety always comes first!

Operating Environment

Remember to follow any special regulations in force in any area and always switch off your phone whenever it is forbidden to use it, or when it may cause interference or danger.

When connecting the phone or any accessory to another device, read its user's guide for detailed safety instructions. Do not connect incompatible products.

As with other mobile radio transmitting equipment, users are advised that for the satisfactory operation of the equipment and for the safety of personnel, it is recommended that the equipment should only be used in the normal operating position (held to your ear with the antenna pointing over your shoulder).

Electronic Devices

Most modern electronic equipment is shielded from radio frequency (RF) signals. However, certain electronic equipment may not be shielded against the RF signals from your wireless phone.

Pacemakers

Pacemaker manufacturers recommend that a minimum separation of 6 inches (20 cm.) be maintained between a handheld wireless phone and a pacemaker to avoid potential interference with the pacemaker. These recommendations are consistent with the independent research by and recommendations of Wireless Technology Research. Persons with pacemakers:

- Should always keep the phone more than 6 inches (20 cm) from their pacemaker when the phone is switched on;
- Should not carry the phone in a breast pocket;
- Should use the ear opposite the pacemaker to minimize the potential for interference.
- If you have any reason to suspect that interference is taking place, switch off your phone immediately.

Hearing Aids

Some digital wireless phones may interfere with some hearing aids. In the event of such interference, you may want to consult your service provider.

Other Medical Devices

Operation of any radio transmitting equipment, including cellular phones, may interfere with the functionality of inadequately protected medical devices. Consult a physician or the manufacturer of the medical device to determine if they are adequately shielded from external RF energy or if you have any questions. Switch off your phone in health care facilities when any regulations posted in these areas instruct you to do so. Hospitals or health care facilities may be using equipment that could be sensitive to external RF energy.

Vehicles

RF signals may affect improperly installed or inadequately shielded electronic systems in motor vehicles (e.g. electronic fuel injection systems, electronic anti-skid (anti-lock) braking systems, electronic speed control systems, air bag systems). Check with the manufacturer or its representative regarding your vehicle. You should also consult the manufacturer of any equipment that has been added to your vehicle.

Posted Facilities

Switch your phone off in any facility where posted notices so require.

Potentially Explosive Atmospheres

Switch off your phone when in any area with a potentially explosive atmosphere and obey all signs and instructions. Sparks in such areas could cause an explosion or fire resulting in bodily injury or even death.

Users are advised to switch off the phone while at a refueling point (service station). Users are reminded of the need to observe restrictions on the use of radio equipment in fuel depots (fuel storage and distribution areas), chemical plants or where blasting operations are in progress.

Areas with a potentially explosive atmosphere are often but not always clearly marked. They include below deck on boats; chemical transfer or storage facilities; vehicles using liquefied petroleum gas (such as propane or butane); areas where the air contains chemicals or particles, such as grain, dust or metal powders; and any other area where you would normally be advised to turn off your vehicle engine.

Vehicles

Only qualified personnel should service the phone, or install the phone in a vehicle. Faulty installation or service may be dangerous and may invalidate any warranty which may apply to the unit.

Check regularly that all wireless phone equipment in your vehicle is mounted and operating properly.

Do not store or carry flammable liquids, gases or explosive materials in the same compartment as the phone, its parts or accessories.

For vehicles equipped with an air bag, remember that an air bag inflates with great force. Do not place objects, including both installed or portable wireless equipment, in the area over the air bag or in the air bag deployment area. If in-vehicle wireless equipment is improperly installed and the air bag inflates, serious injury could result.

Switch off your phone before boarding an aircraft. The use of wireless telephones in an aircraft may be dangerous to the operation of the aircraft, disrupt the wireless telephone network and may be illegal.

Failure to observe these instructions may lead to the suspension or denial of telephone services to the offender, or legal action, or both.

Emergency Calls

IMPORTANT!

This phone, like any cellular phone, operates by using radio signals, cellular and landline networks, as well as user-programmed functions which cannot guarantee connection in all conditions. Therefore, you should never rely solely upon any cellular phone for essential communications (e.g. medical emergencies).

Remember, to make or receive any calls, the phone must be switched on and in a service area with adequate cellular signal strength.

Emergency calls may not be possible on all cellular phone networks or when certain network services and/or phone features are in use. Check with local cellular service providers.

To make an emergency call

- 1)** If the phone is not on, switch it on by pressing and holding the power key.
- 2)** Press and hold **CLR** for several seconds to ready the phone for calls.
- 3)** Enter the emergency number for your present location (e.g., 911 or another official emergency number). Emergency numbers vary by location.
- 4)** Press **SEND**.

If certain features are in use (e.g., Keyguard), you may first need to turn those features off before you can make an emergency call. Consult this document and your local cellular service provider.

When making an emergency call, remember to give all the necessary information as accurately as possible. Remember that your cellular phone may be the only means of communication at the scene of an accident - do not end the call until given permission to do so.

Radio Frequency (RF) Signals

Your wireless handheld portable telephone is a low power radio transmitter and receiver. When it is ON, it receives and also sends out radio frequency (RF) signals.

In August, 1996, the Federal Communications Commission (FCC) adopted RF exposure guidelines with safety levels for handheld wireless phones. Those guidelines are consistent with safety standards previously set by both U.S. and international standards bodies:

ANSI C95.1 (1992)*, NCRP Report 86 (1986)*, ICNIRP (1996)*.

Those standards were based on comprehensive and periodic evaluations of the relevant scientific literature. For example, over 120 scientists, engineers, and physicians from universities, government health agencies and industry reviewed the available body of research to develop the ANSI Standard (C95.1).

The design of your phone complies with the FCC guidelines (and those standards).

For body worn operation, to maintain compliance with FCC RF exposure guidelines, use only Nokia approved accessories. When carrying the phone while it is on, use the specific Nokia belt-clip that has been tested for compliance.

Use of non-Nokia-approved accessories may violate FCC RF exposure guidelines and should be avoided.

*American National Standards Institute, National Council on Radiation Protection and Measurements; International Commission on Non-Ionizing Radiation Protection.

Using This Guide

The cellular phone described in this guide is approved for use in AMPS networks.

A number of features included in this guide are called Network Services. They are special services provided by cellular service providers. Before you can take advantage of any of these Network Services, you must subscribe to the service(s) you require from your home service provider. You can then activate these functions as described in this guide.

The manual activation commands for various network services are not presented in this guide (e.g., using * and # characters for activating or deactivating services). The phone nevertheless is capable of handling commands given in that form. For these commands, please consult with your service providers.

Care and Maintenance

Your phone is a product of superior design and craftsmanship and should be treated with care. The suggestions below will help you to fulfil any warranty obligations and allow you to enjoy this product for many years.

Keep the phone and all its parts and accessories out of small children's reach.

Keep the phone dry. Precipitation, humidity and liquids contain minerals that will corrode electronic circuits.

Do not use or store the phone in dusty, dirty areas as its moving parts can be damaged.

Do not store the phone in hot areas. High temperatures can shorten the life of electronic devices, damage batteries, and warp or melt certain plastics.

Do not store the phone in cold areas. When the phone warms up (to its normal operating temperature), moisture can form inside the phone, which may damage the phone's electronic circuit boards.

Do not attempt to open the phone. Non-expert handling of the phone may damage it.

Do not drop, knock or shake the phone. Rough handling can break internal circuit boards.

Do not use harsh chemicals, cleaning solvents, or strong detergents to clean the phone. Wipe it with a soft cloth slightly dampened in a mild soap-and-water solution.

If the phone or any of its accessories are not working properly, take them to your nearest qualified service facility. The personnel there will assist you, and if necessary, arrange for service.

Troubleshooting

If the power does not come on or stay on

Make sure the battery is properly installed and charged.

Be sure that the contacts on the battery and the charging stand are clean.

Battery charge may be too low for operation. Check the display and listen for the low battery warning tones.

If the power comes on, but the phone does not work

Check the NO SVC indicator, you might be out of the cellular service area.

Make sure that the antenna is properly installed and if your phone has an extendable antenna, make sure that the antenna is extended to its full length.

Check if there is an error message on the display after switching the phone on. If so, contact your local dealer.

Technical Information

Weight:	7.6 oz. with Extended 800 mAh NiCd Battery 6.7 oz. with Slim 800 mAh NiMH Battery
Transmitting Power:	0.6 W (+ 2 dB - 4 dB)
Operating Voltage:	4.8 V (Internal Battery), 120 V (AC), 12 V (car)
Frequency Band:	824.040 - 848.970 MHz (Tx) 869.040 - 893.970 MHz (Rx)
Number of Channels:	832
Memory Locations:	40
Memory Capacity:	Alpha: 16 characters/location Numeric: 32 digits/location

Nokia, Connecting People and the Original Accessories logos are trademarks of Nokia Corporation and/or its affiliates.

The information contained in this User Guide was written for Nokia phone NHA-5NA.

The right to make changes and improvements to any of the products described in this guide without prior notice is reserved.

© 1999/2000 Nokia Mobile Phones. All rights reserved.

© 1999 TRACFONE is a registered trademark of Topp Telecom, Inc.

These commodities are authorized by the U.S. Government for export only to Canada, Mexico, or the United States. They may not be resold, diverted, transferred, or otherwise disposed of in any other country, either in their original form or after being incorporated through an intermediate process into other end-items, without the written approval of the U.S. Department of State.

9. Nokia 1-Year Limited Warranty

Nokia Mobile Phones, Inc. ("NMP") warrants that this cellular phone ("Product") is free from defects in material and workmanship that result in Product failure during normal usage, according to the following terms and conditions:

1. The limited warranty for the Product extends for ONE (1) year beginning on the date of the purchase of the Product.
2. The limited warranty extends to the original purchaser of the Product ("Consumer") and is not assignable or transferable to any subsequent purchaser/end-user.
3. The limited warranty extends only to Consumers who purchase the Product in the United States.
4. During the limited warranty period, NMP will repair, or replace, at NMP's option, any defective parts, or any parts that will not properly operate for their intended use with new or factory rebuilt replacement items if such repair or replacement is needed because of product malfunction or failure during normal usage. No charge will be made to the Consumer for any such parts. NMP will also pay for the labor charges incurred by NMP in repairing or replacing the defective parts. The limited warranty does not cover defects in appearance, cosmetic, decorative or structural items, including framing, and any non-operative parts. NMP's limit of liability under the limited warranty shall be the actual cash value of the Product at the time the Consumer returns the Product for repair, determined by the price paid by the Consumer for the Product less a reasonable amount for usage. NMP shall not be liable for any other losses or damages. These remedies are the Consumer's exclusive remedies for breach of warranty.
5. Upon request from NMP, the Consumer must prove the date of the original purchase of the Product by a dated bill of sale or dated itemized receipt.
6. The Consumer shall bear the cost of shipping the Product to NMP in Melbourne, Florida. NMP shall bear the cost of shipping the Product back to the Consumer after the completion of service under this limited warranty.
7. The Consumer shall have no coverage or benefits under this limited warranty if any of the following conditions are applicable:

a) The Product has been subject to abnormal use, abnormal conditions, improper storage, exposure to moisture or dampness, unauthorized modifications, unauthorized connections, unauthorized repair, misuse, neglect, abuse, accident, alteration, improper installation, or other acts which are not the fault of NMP, including damage caused by shipping.

b) The Product has been damaged from external causes such as collision with an object, or from fire, flooding, sand, dirt, windstorm, lightning, earthquake or damage from exposure to weather conditions, an Act of God, or battery leakage, theft, blown fuse, or improper use of any electrical source, or damage caused by the connection to other products not recommended for interconnection by NMP.

c) NMP was not advised by the Consumer in writing of the alleged defect or malfunction of the Product within fourteen (14) days after the expiration of the applicable limited warranty period.

d) The Product serial number plate or the accessory data code has been removed, defaced or altered.

e) The defect or damage was caused by the defective function of the cellular system or by inadequate signal reception by the external antenna.

8. If a problem develops during the limited warranty period, the Consumer shall take the following step-by-step procedure:

a) The Consumer shall return the Product to the place of purchase for repair or replacement processing.

b) If "a" is not convenient because of distance (more than 50 miles) or for other good cause, the Consumer shall ship the Product prepaid and insured to:

Nokia Mobile Phones, Inc.
Attn: Repair Department
795 West Nasa Blvd.
Melbourne, FL 32901

c) The Consumer shall include a return address, daytime phone number and/or fax number, complete description of the problem, proof of purchase and service agreement (if applicable). Expenses related to removing the Product from an installation are not covered under this limited warranty.

d) The Consumer will be billed for any parts or labor charges not covered by this limited warranty. The Consumer will be responsible for any expenses related to reinstallation of the Product.

e) NMP will repair or authorize the repair of the Product under the limited warranty within 30 days after receipt of the Product by NMP or an NMP authorized service center. If NMP cannot perform repair covered under this limited warranty within 30 days, or after a reasonable number of attempts to repair the same defect, NMP at its option, will provide a replacement Product or refund the purchase price of the Product less a reasonable amount for usage.

f) If the Product is returned to NMP during the limited warranty period, but the problem with the Product is not covered under the terms and conditions of this limited warranty, the Consumer will be notified and given an estimate of the charges the Consumer must pay to have the Product repaired, with all shipping charges billed to the Consumer. If the estimate is refused, the Product will be returned freight collect. If the Product is returned to NMP after the expiration of the limited warranty period, NMP's normal service policies shall apply and the Consumer will be responsible for all shipping charges.

9. The Product consists of newly assembled equipment that may contain used components that have been reprocessed to allow machine compliance with Product performance and reliability specifications.

10. ANY IMPLIED WARRANTY OF MERCHANTABILITY, OR FITNESS FOR A PARTICULAR PURPOSE OR USE, SHALL BE LIMITED TO THE DURATION OF THE FOREGOING LIMITED WRITTEN WARRANTY. OTHERWISE, THE FOREGOING LIMITED WARRANTY IS THE CONSUMER'S SOLE AND EXCLUSIVE REMEDY AND IS IN LIEU OF ALL OTHER WARRANTIES, EXPRESS OR IMPLIED. NMP SHALL NOT BE LIABLE FOR SPECIAL, INCIDENTAL OR CONSEQUENTIAL DAMAGES, INCLUDING BUT NOT LIMITED TO, LOSS OF ANTICIPATED BENEFITS OR PROFITS, LOSS OF SAVINGS OR REVENUE, PUNITIVE DAMAGES, LOSS OF USE OF THE PRODUCT OR ANY ASSOCIATED EQUIPMENT, COST OF CAPITAL, COST OF ANY SUBSTITUTE EQUIPMENT OR FACILITIES, DOWNTIME, THE CLAIMS OF ANY THIRD PARTIES, INCLUDING CUSTOMERS, AND INJURY TO PROPERTY, RESULTING FROM THE PURCHASE OR USE OF THE PRODUCT OR ARISING FROM BREACH OF THE WARRANTY, BREACH OF CONTRACT, NEGLIGENCE, STRICT TORT, OR ANY OTHER LEGAL OR EQUITABLE THEORY, EVEN IF NMP KNEW OF THE LIKELIHOOD OF SUCH DAMAGES. NMP SHALL NOT BE LIABLE FOR DELAY IN RENDERING SERVICE UNDER THE LIMITED WARRANTY, OR LOSS OF USE DURING THE PERIOD THAT THE PRODUCT IS BEING REPAIRED.

11. Some states do not allow limitation of how long an implied warranty lasts, so the above one-year warranty limitation may not apply to you (the Consumer). Some states do not allow the exclusion or limitation of incidental and consequential damages, so certain of the above limitations or exclusions may not apply to you (the Consumer). This limited warranty gives the Consumer specific legal rights and the Consumer may also have other rights which vary from state to state.

12. NMP neither assumes nor authorizes any authorized service center or any other person or entity to assume for it any other obligation or liability beyond that which is expressly provided for in this limited warranty including the provider or seller of any extended warranty or service agreement.

13. This is the entire warranty between NMP and the Consumer, and supersedes all prior and contemporaneous agreements or understandings, oral or written, and all communications relating to the Product, and no representation, promise or condition not contained herein shall modify these terms.

14. This limited warranty allocates the risk of failure of the Product between the Consumer and NMP. The allocation is recognized by the Consumer and is reflected in the purchase price of the Product.

15. Any action or lawsuit for breach of warranty must be commenced within eighteen (18) months following delivery of the Product.

16. Questions concerning this limited warranty may be directed to:

Customer Service, USA
Nokia Mobile Phones, Inc.
7725 Woodland Center Boulevard, Suite #150
Tampa, Florida 33614
Teléfono: 1-888-NOKIA2U (1-888-665-4228)
Usuarios de TTY : 1-800-24NOKIA (1-800-246-6542)
Fax.: (1) 813-249-9619

17. The limited warranty period for NMP supplied attachments and accessories is specifically defined within their own warranty cards and packaging.

© Nokia is a registered trademark of Nokia Corporation.

NOTES

Para obtener un manual del usuario en español favor de llamar o enviar un fax al teléfono 1-888-NOKIA2U, fax 813-249-9619.
